

## Digital Still Camera

# User's Guide/ Troubleshooting

### Operating Instructions

Before operating the unit, please read this manual and "Read This First" (separate volume) thoroughly, and retain it for future reference.

### Owner's Record

The model and serial numbers are located on the bottom. Record the serial number in the space provided below. Refer to these numbers whenever you call upon your Sony dealer regarding this product.

Model No. DSC-S60/S80/ST80/S90

Serial No. \_\_\_\_\_



"Read This First" (separate volume)

Explains the set-up and basic operations for shooting/playback with your camera.



Enjoying the camera



Using the menu



Using the Setup screen



Using your computer



Printing still images



Connecting your camera to your TV



Troubleshooting



Others



Index

Additional information on this product and answers to frequently asked questions can be found at our Customer Support Website.

<http://www.sony.net/>



Printed on 100% recycled paper using VOC (Volatile Organic Compound)-free vegetable oil based ink.



2590639120

Printed in Japan

© 2005 Sony Corporation

## WARNING

To prevent fire or shock hazard, do not expose the unit to rain or moisture.

## For Customers in the U.S.A. and Canada (DSC-S90 only)

### RECYCLING NICKEL METAL HYDRIDE BATTERIES

Nickel Metal Hydride batteries are recyclable.

You can help preserve our environment by returning your used rechargeable batteries to the collection and recycling location nearest you.



For more information regarding recycling of rechargeable batteries, call toll free 1-800-822-8837, or visit <http://www.rbrbc.org/>

**Caution:** Do not handle damaged or leaking Nickel Metal Hydride batteries.

## For Customers in the U.S.A.

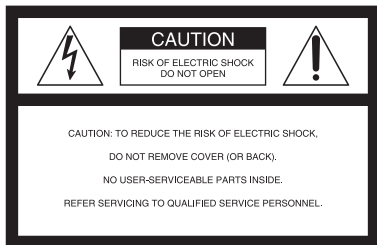

This symbol is intended to alert the user to the presence of uninsulated "dangerous voltage" within the product's enclosure that may be of sufficient magnitude to constitute a risk of electric shock to persons.



This symbol is intended to alert the user to the presence of important operating and maintenance (servicing) instructions in the literature accompanying the appliance.

If you have any questions about this product, you may call:

Sony Customer Information Services Center  
1-800-222-SONY (7669)

The number below is for the FCC related matters only.

## Regulatory Information

### Declaration of Conformity

Trade Name: SONY  
Model No.: DSC-S60  
Responsible Party: Sony Electronics Inc.  
Address: 16450 W. Bernardo Dr,  
San Diego, CA 92127U.S.A.  
Telephone No.: 858-942-2230

This device complies with Part 15 of the FCC Rules. Operation is subject to the following two conditions: (1) This device may not cause harmful interference, and (2) this device must accept any interference received, including interference that may cause undesired operation.

### Declaration of Conformity

Trade Name: SONY  
Model No.: DSC-S90  
Responsible Party: Sony Electronics Inc.  
Address: 16450 W. Bernardo Dr,  
San Diego, CA 92127U.S.A.  
Telephone No.: 858-942-2230

This device complies with Part 15 of the FCC Rules. Operation is subject to the following two conditions: (1) This device may not cause harmful interference, and (2) this device must accept any interference received, including interference that may cause undesired operation.

## CAUTION

You are cautioned that any changes or modifications not expressly approved in this manual could void your authority to operate this equipment.

## Note:

This equipment has been tested and found to comply with the limits for a Class B digital device, pursuant to Part 15 of the FCC Rules. These limits are designed to provide reasonable protection against harmful interference in a residential installation. This equipment generates, uses, and can radiate radio frequency energy and, if not installed and used in accordance with the instructions, may cause harmful interference to radio communications. However, there is no guarantee that interference will not occur in a particular installation. If this equipment does cause harmful interference to radio or television reception, which can be determined by turning the equipment off and on, the user is encouraged to try to correct the interference by one or more of the following measures:

- Reorient or relocate the receiving antenna.
- Increase the separation between the equipment and receiver.
- Connect the equipment into an outlet on a circuit different from that to which the receiver is connected.
- Consult the dealer or an experienced radio/TV technician for help.

The supplied interface cable must be used with the equipment in order to comply with the limits for a digital device pursuant to Subpart B of Part 15 of FCC Rules.

## For Customers in Europe

This product has been tested and found compliant with the limits set out in the EMC Directive for using connection cables shorter than 3 meters (9.8 feet).

## Attention

The electromagnetic fields at the specific frequencies may influence the picture and sound of this camera.

## Notice



If static electricity or electromagnetism causes data transfer to discontinue midway (fail), restart the application or disconnect and connect the communication cable (USB, etc.) again.

## Disposal of Old Electrical & Electronic Equipment (Applicable in the European Union and other European countries with separate collection systems)



This symbol on the product or on its packaging indicates that this product shall not be treated as household waste. Instead it shall be handed over to the applicable collection point for the recycling of electrical and electronic equipment. By ensuring this product is disposed of correctly, you will help prevent potential negative consequences for the environment and human health, which could otherwise be caused by inappropriate waste handling of this product. The recycling of materials will help to conserve natural resources. For more detailed information about recycling of this product, please contact your local city office, your household waste disposal service or the shop where you purchased the product.

## Notice for customers in the United Kingdom (DSC-S90/S80/ST80 only)

A moulded plug complying with BS 1363 is fitted to this equipment for your safety and convenience. Should the fuse in the plug supplied need to be replaced, a fuse of the same rating as the supplied one and approved by ASTA or BSI to BS 1362, (i.e., marked with an  or  mark) must be used.

If the plug supplied with this equipment has a detachable fuse cover, be sure to attach the fuse cover after you change the fuse. Never use the plug without the fuse cover. If you should lose the fuse cover, please contact your nearest Sony service station.

# Notes on using your camera

## Types of “Memory Stick” that can be used (not supplied)

The IC recording medium used by this camera is a “Memory Stick”. There are two types of “Memory Stick”.

- “Memory Stick”: you can use a “Memory Stick” with your camera.

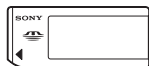

- “Memory Stick Duo”: you can use a “Memory Stick Duo” by inserting it into a Memory Stick Duo Adaptor.



Memory Stick Duo Adaptor

- For details on “Memory Stick”, see page 91.

## Notes on the Nickel-Metal Hydride battery (supplied with DSC-S80/S90 only)

- Charge both of the supplied Ni-MH batteries before using the camera for the first time. (→ *step 1* in “*Read This First*”)
- The batteries can be charged even if they are not completely discharged. Also, even if batteries are not fully charged, you can use the partially charged capacity of the batteries as is.
- If you do not intend to use the batteries for a long time, use up the existing charge and remove them from your camera, then store them in a cool, dry place. This is to maintain the batteries’ functions (page 93).
- For details on the usable batteries, see page 93.

## Note on the battery pack NP-NH25 (supplied with DSC-ST80 only)

Refer to the operating instructions “Cyber-shot Station”.

## Carl Zeiss lens

This camera is equipped with a Carl Zeiss lens which is capable of reproducing sharp images with excellent contrast.

The lens for this camera has been produced under a quality assurance system certified by Carl Zeiss in accordance with the quality standards of Carl Zeiss in Germany.

## No compensation for contents of the recording

- The contents of the recording cannot be compensated for if recording or playback is not possible due to a malfunction of your camera or recording media, etc.

## Back up recommendation

- To avoid the potential risk of data loss, always copy (back up) data to other medium.

## Back up of the internal memory

- If you turn off the power by opening the battery/ “Memory Stick” cover, etc. during the access lamp is lit, the data in the internal memory may be corrupted. Be sure to back up the data to avoid the potential risk of data loss. See pages 23, 58 on how to back up the data.

## Notes on recording/playback

- This camera is neither dust-proof, nor splash-proof, nor water-proof. Read “Precautions” (page 95) before operating the camera.
- Before you record one-time events, make a trial recording to make sure that the camera is working correctly.
- Be careful not to get the camera wet. Water entering the inside of the camera may cause malfunctions which in some cases may not be repairable.
- Do not aim the camera at the sun or other bright light. This may cause irrecoverable damage to your eyes. Or it may cause the malfunction of your camera.
- Do not use the camera near a location that generates strong radio waves or emits radiation. The camera may not be able to record or play back properly.
- Using the camera in sandy or dusty locations may cause malfunctions.
- If moisture condensation occurs, remove it before using the camera (page 95).

- Do not shake or strike the camera. In addition to malfunctions and an inability to record images, this may render the recording medium unusable, or cause image data breakdown, damage or loss.
- Clean the flash surface before use. The heat of flash emission may cause dirt on the flash surface to become discolored or to stick to the flash surface, resulting in insufficient light emission.

## **Notes on the LCD screen, LCD finder (for models with an LCD finder) and lens**

- The LCD screen and the LCD finder are manufactured using extremely high-precision technology so over 99.99% of the pixels are operational for effective use. However, there may be some tiny black points and/or bright points (white, red, blue, or green in color) that constantly appear on the LCD screen and the LCD finder. These points are normal in the manufacturing process and do not affect the recording in any way.
- Exposing the LCD screen, the finder, or the lens to direct sunlight for long periods may cause malfunctions. Be careful when placing the camera near a window or outdoors.
- Do not press against the LCD screen. The screen may be discolored and that may cause a malfunction.
- Images may trail across on the LCD screen in a cold location. This is not a malfunction.
- This camera is equipped with a power zoom lens. Be careful not to bump the lens, and be careful not to apply force to it.

## **On image data compatibility**

- This camera conforms with DCF (Design rule for Camera File system universal standard) established by JEITA (Japan Electronics and Information Technology Industries Association).
- Playback of images recorded with your camera on other equipment and playback of images recorded or edited with other equipment on your camera are not guaranteed.

## **Warning on copyright**

Television programs, films, videotapes, and other materials may be copyrighted. Unauthorized recording of such materials may be contrary to the provisions of the copyright laws.

## **The pictures used in this manual**

The photographs used as examples of pictures in this manual are reproduced images, and are not actual images shot using this camera.

## **On illustrations**

Illustrations used in this manual are of the DSC-S60 unless noted otherwise.

# For full use of the digital still camera

## Prepare the camera and shoot in auto adjustment mode

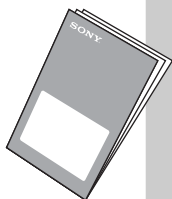

### ***“Read This First” (separate volume)***

- 1 Prepare the battery
- 2 Turn the camera on/set the clock
- 3 Insert a “Memory Stick” (not supplied)
- 4 Select the image size for use
- 5 Shoot images easily (Auto adjustment mode)  
Shoot still images (Scene Selection)
- 6 View/Delete images

## Get more friendly with your camera

*This manual*

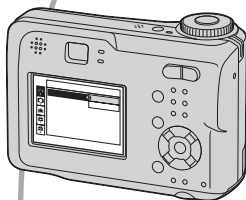

- Shoot with your favorite settings (Program auto shooting/ Manual shooting) → page 26
- Enjoy various shooting/playback using the menu → page 29
- Change the default settings → page 45

## Connect your camera to a PC or a printer

*This manual*



- Copy your images to a computer and enjoy editing them in various ways → page 56
- Print images by connecting your camera directly to a printer (PictBridge compliant printers only) → page 69

# Table of contents











Notes on using your camera .....	4
----------------------------------	---







## Enjoying the camera







Basic techniques for better images .....	10
Focus – Focusing on a subject successfully .....	10
Exposure – Adjusting the light intensity .....	11
Color – On the effects of lighting .....	12
Quality – On “image quality” and “image size” .....	13
Identifying parts .....	15
Indicators on the screen .....	17
Changing the screen display .....	21
Number of still images and recording time of movies .....	22
When you do not have a “Memory Stick” (Recording with the internal memory) .....	23
Battery life and number of images that can be recorded/viewed .....	24
Using the mode dial .....	26

## Using the menu

<i>Using menu items</i> .....	29
<i>Menu items</i> .....	30
Shooting menu .....	31
 (EV)	
 (Focus)	
 (Metering Mode)	
WB (White Bal)	
ISO	
 (P.Quality)	
Mode (REC Mode)	
 (Interval)	
 (Flash Level)	
PFX (P.Effect)	
 (Saturation)	
 (Contrast)	
 (Sharpness)	
 (Setup)	

Viewing menu .....	38
 (Folder)	
 (Protect)	
DPOF	
 (Print)	
 (Slide)	
 (Resize)	
 (Rotate)	
 (Divide)	
 (Setup)	
Trimming	

## Using the Setup screen

<i>Using Setup items</i> .....	45
 Camera 1 .....	46
AF Mode	
Digital Zoom	
Date/Time	
Red Eye Reduction	
AF Illuminator	
Auto Review	
 Camera 2 .....	49
Enlarged Icon	
 Internal Memory Tool .....	50
Format	
 Memory Stick Tool .....	51
Format	
Create REC. Folder	
Change REC. Folder	
Copy	
 Setup 1 .....	53
LCD Backlight	
Beep	
 Language	
Initialize	
 Setup 2 .....	54
File Number	
USB Connect	
Video Out	
Clock Set	

## Using your computer

Enjoying your Windows computer .....	56
Copying images to your computer.....	58
Viewing image files stored on a computer with your camera (using a “Memory Stick”) .....	64
Using the supplied software .....	65
Using your Macintosh computer .....	67

## Printing still images

How to print still images .....	69
Printing images directly using a PictBridge compliant printer .....	70
Printing at a shop .....	73

## Connecting your camera to your TV

Viewing images on a TV screen .....	75
-------------------------------------	----

## Troubleshooting

Troubleshooting .....	77
Warning indicators and messages .....	88

## Others

On the “Memory Stick” .....	91
On the battery charger and the batteries .....	93
Precautions .....	95
Specifications .....	96



<b>Index</b> .....	98
--------------------	----



# Basic techniques for better images

Focus

Exposure

Color

Quality

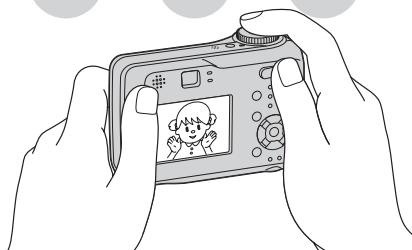

This section describes the basics so you can enjoy your camera. It tells you how to use various camera functions such as the mode dial (page 26), the menus (page 29), and so on.

## Focus *Focusing on a subject successfully*

When you press the shutter button halfway down, the camera adjusts the focus automatically (Auto Focus). Remember to press the shutter button only halfway down.

Press fully down straight away

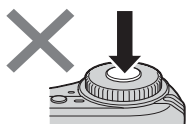

Press halfway down, then

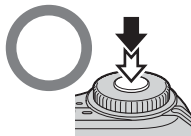

Flashing → lit/beeps



Press fully down

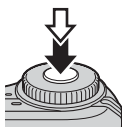

To shoot a still image difficult to focus on → [Focus] (page 32)

If the image looks blurred even after focusing, it may be because of camera shake. → See "Hints for preventing blur" (below).

### Hints for preventing blur

Hold the camera steadily, keeping your arms at your side. Also, you can stabilize the camera by leaning against a tree or a building beside you. Using a tripod, and using the flash in dark places are also recommended.



## Exposure Adjusting the light intensity

You can create various images by adjusting the exposure and the ISO sensitivity. Exposure is the amount of light that the camera will receive when you release the shutter.

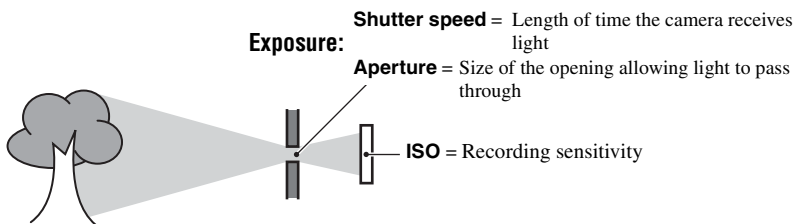

**Overexposure**  
= too much light  
Whitish image



**Correct exposure**



**Underexposure**  
= too little light  
Darker image

The exposure is automatically set to the proper value in the auto adjustment mode. However, you can adjust it manually using the functions below.

### [Manual exposure]:

Allows you to adjust the shutter speed and aperture value manually. → page 27

### [EV]:

Allows you to adjust the exposure that has been determined by the camera. → page 31

### [Metering Mode]:

Allows you to change the part of the subject to be measured to determine the exposure. → page 33

### Characteristics of “shutter speed”



**Faster**  
Moving objects appear stopped.



**Slower**  
Moving objects appear to flow.

### Characteristics of “aperture” (F value)



**Open**  
In-focus range narrows, both backward and forward.



**Close**  
In-focus range widens, both backward and forward.

## Adjusting the ISO sensitivity

ISO is unit of measurement (sensitivity), estimating how much light an image pickup device (equivalent to photo films) receives. Even when the exposure is the same, images differ depending on the ISO sensitivity.

[ISO] adjusts the sensitivity → page 34



### High ISO sensitivity

Records a bright image even when shooting in a dark location. However, the image tends to become noisy.



### Low ISO sensitivity





Records a smoother image.  
However, the image may become darker.

## Color

### On the effects of lighting

The apparent color of the subject is affected by the lighting conditions.

### Example: The color of an image affected by light sources

Weather/lighting	Daylight 	Cloudy 	Fluorescent 	Incandescent 
Characteristics of light	White (standard)	Bluish	Blue-tinged	Reddish

The color tones are adjusted automatically in the auto adjustment mode.  
However, you can adjust color tones manually with [White Bal] (page 34).

## Quality On “image quality” and “image size”

A digital image is made up of a collection of small dots called pixels. If it contains a large number of pixels, the picture becomes large, it takes up more memory, and the image is displayed in fine detail. “Image size” is shown by the number of pixels. Although you cannot see the differences on the screen of the camera, the fine detail and data processing time differ when the image is printed or displayed on a computer screen.

Description of the pixels and the image size

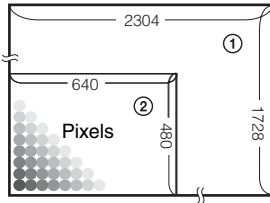

- ① Image size: 4M  
2,304 pixels×1,728 pixels = 3,981,312 pixels
- ② Image size: VGA(E-Mail)  
640 pixels×480 pixels = 307,200 pixels

## Selecting the image size for use (→ *step 4 in “Read This First”*)

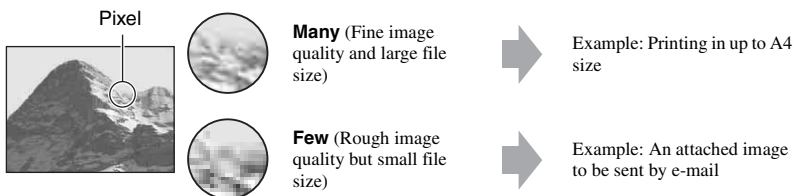

The default settings are marked with ✓.

Image size		Usage guidelines	
✓	4M (2304×1728)	Larger ↑ ↓ Smaller	For printing high density images in A4 or A5 size  For printing in postcard size For recording a large number of images For attaching images to e-mail or creating web pages
	3:2 (2304×1536)*		
	3M (2048×1536)		
	1M (1280×960)		
	VGA(E-Mail) (640×480)		

\* Images are recorded in the same 3:2 aspect ratio as photograph printing paper or postcards, etc.

## Selecting the image quality (compression ratio) in combination (page 34)

You can select the compression ratio when digital images are saved. When you select a high compression ratio, the image lacks the fineness of detail, but has a smaller file size.

# Identifying parts

See the pages in parentheses for details of operation.

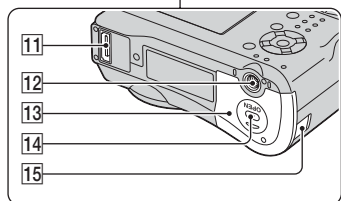
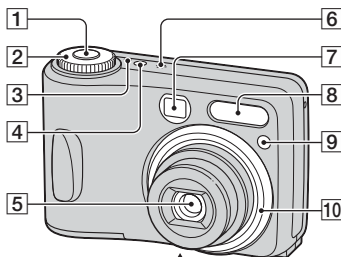

- 1** Shutter button (→ *step 5 in “Read This First”*)
- 2** Mode dial (26)
- 3** POWER lamp (→ *step 2 in “Read This First”*)
- 4** POWER button (→ *step 2 in “Read This First”*)
- 5** Lens
- 6** Microphone
- 7** Finder window
- 8** Flash (→ *step 5 in “Read This First”*)
- 9** Self-timer lamp (→ *step 5 in “Read This First”*)/AF illuminator (48)
- 10** Lens ring

Removing

Attaching

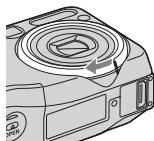
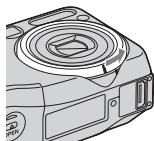

- 11** Multi connector (59, 75)

- 12** Tripod receptacle

- Use a tripod with a screw length of less than 5.5 mm (7/32 inch). You will be unable to firmly secure the camera to tripods having longer screws, and may damage the camera.

- 13** Battery/“Memory Stick” cover (→ *step 1 and 3 in “Read This First”*)

- 14** OPEN button (→ *step 1 and 3 in “Read This First”*)

- 15** AC Adaptor cord cover

To use the AC-LS5K AC Adaptor (not supplied)

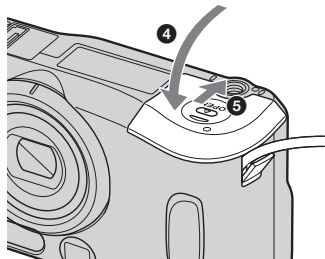
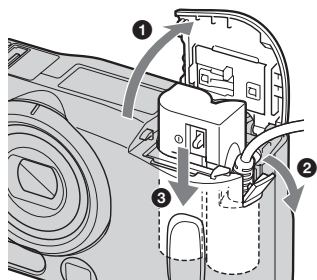

Do not pinch the cord when you close the cover.

### DSC-S90

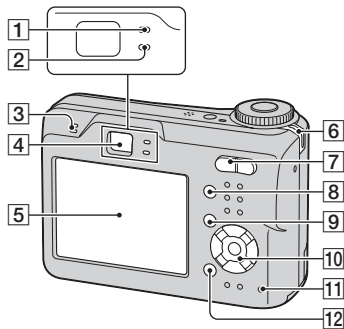

### DSC-S80/ST80/S60

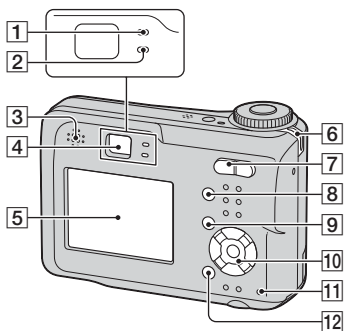

- 1 AE/AF lock lamp/self-timer lamp (green) (→ step 5 in “Read This First”)
- 2 Flash charge lamp/Record lamp (orange) (→ step 5 in “Read This First”)
- 3 Speaker
- 4 Finder (→ step 5 in “Read This First”)
- 5 LCD screen (17)
- 6 Hook for wrist strap (→ “Read This First”)

- 7 For shooting: Zoom (W/T) button (→ step 5 in “Read This First”)  
For viewing:  $\ominus/\oplus$  (Playback zoom) button/ $\square$  (Index) button (→ step 6 in “Read This First”)
- 8  $\square$  (Display/LCD on/off) button (21)
- 9 MENU button (29)
- 10 Control button  
Menu on:  $\blacktriangle/\blacktriangledown/\blacktriangleleft/\blacktriangleright/\bullet$  (→ step 2 in “Read This First”)  
Menu off:  $\text{lightning bolt}/\text{smiley face}/\text{circle with X}/\text{hand}$  (→ step 5 in “Read This First”)  
Mode dial “M”: Shutter speed/aperture value (27)
- 11 Access lamp (→ step 4 in “Read This First”)
- 12  $\text{grid}/\text{trash}$  (Image Size/Delete) button (→ step 4 and 6 in “Read This First”)

# Indicators on the screen

See the pages in parentheses for details of operation.

## When shooting still images

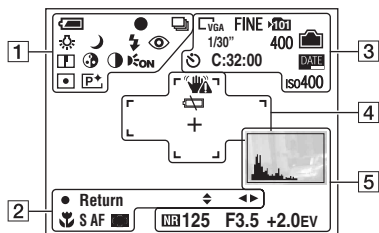

## When shooting movies

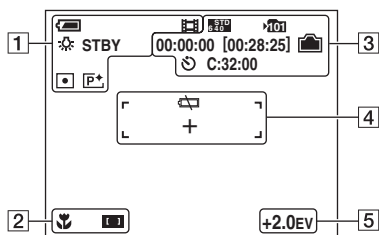

1

Display	Indication
	Battery remaining (→ step 1 in “Read This First”)
	AE/AF lock (→ step 5 in “Read This First”)
	Recording mode (26, 35)
	White balance (34)
STBY REC	Standby/Recording a movie (→ step 5 in “Read This First”)
	Mode dial (Scene Selection) (→ step 5 in “Read This First”)
P M	Mode dial (26)
	Flash mode (→ step 5 in “Read This First”)
	Red-eye reduction (47)
	Sharpness (37)
	Saturation (37)
	Contrast (37)
	AF illuminator (48)
	Metering mode (33)
	Picture effect (36)

2

Display	Indication
	Manual exposure setup mode (27)
	Macro (→ step 5 in “Read This First”)
S AF M AF	AF mode (46)
	AF range finder frame indicator (32)
1.0m	Focus preset distance (32)
	Manual exposure (27)
	Set

3

Display	Indication
	Image size (→ <i>step 4 in "Read This First"</i> )
	Image quality (34)
	Recording folder (51) • This does not appear when using the internal memory.
	Remaining internal memory capacity (22)
	Remaining "Memory Stick" capacity (22)
00:00:00 [00:28:05]	Recording time [maximum recordable time] (22)
1/30"	Multi Burst interval (36)
400	Remaining number of recordable images (22)
	Self-timer (→ <i>step 5 in "Read This First"</i> )
C:32:00	Self-diagnosis display (88)
	Date/Time (47)
iso400	ISO number (34)

4

Display	Indication
	Vibration warning (10) • Indicates vibration will prevent you from shooting clear images. Even if the vibration warning appears, you can still shoot images. However, we recommend using the flash or a tripod to increase the amount of light.
	Low battery warning (24, 88)
+	Spot metering cross hair (33)
	AF range finder frame (32)

5

Display	Indication
	Histogram (21, 31)
	NR slow shutter (27)
125	Shutter speed (27)
F3.5	Aperture value (27)
+2.0EV	EV level value (31)
 (not displayed on the screen on the previous page)	Menu/Guide menu (29)

## When playing back still images

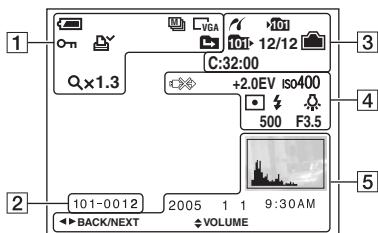

## When playing back movies

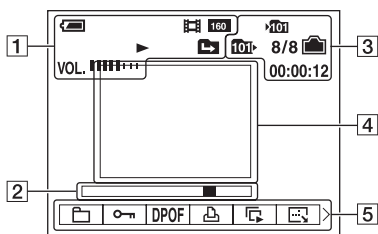

1

Display	Indication
	Battery remaining (→ step 1 in “Read This First”)
	Image size (→ step 4 in “Read This First”)
	Recording mode (26, 35)
	Playback (→ step 6 in “Read This First”)
	Volume (→ step 6 in “Read This First”)
	Protect (39)
	Print order (DPOF) mark (73)
	Change folder (38) <ul style="list-style-type: none"> <li>This does not appear when using the internal memory.</li> </ul>
	Zoom scaling (→ step 6 in “Read This First”)
	Frame by frame playback (35)

2





Display	Indication
101-0012	Folder-file number (38)
	Playback bar (→ step 6 in “Read This First”)

3



Display	Indication
	PictBridge connecting (71)
	Recording folder (51) <ul style="list-style-type: none"> <li>This does not appear when using the internal memory.</li> </ul>
	Playback folder (38) <ul style="list-style-type: none"> <li>This does not appear when using the internal memory.</li> </ul>
	Remaining internal memory capacity (22)
	Remaining “Memory Stick” capacity (22)

Display	Indication
8/8 12/12	Image number/Number of images recorded in selected folder (38)
C:32:00	Self-diagnosis display (88)
00:00:12	Counter (→ <i>step 6</i> in “ <i>Read This First</i> ”)

#### 4

Display	Indication
	Do not disconnect the cable for multi-use terminal/the USB cable (72)
+2.0EV	EV level value (31)
iso400	ISO number (34)
	Metering mode (33)
	Flash
	White balance (34)
500	Shutter speed (27)
F3.5	Aperture value (27)
	Playback image (→ <i>step 6</i> in “ <i>Read This First</i> ”)

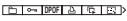

#### 5

Display	Indication
	Histogram (21, 31) •  appears when histogram display is disabled.
2005 1 1	Recording date/time of the playback image (47)
	Menu/Guide menu (29)
◀▶ BACK/ NEXT	Select images
⬇️ VOLUME	Adjust volume

# Changing the screen display

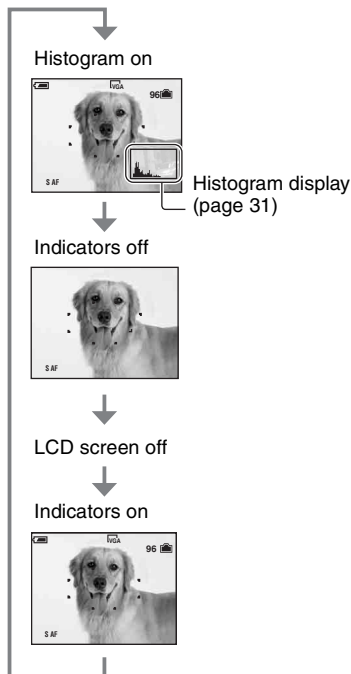
Each time you press the  (Display/LCD on/off) button, the display changes as follows.



- A large difference in the histogram displayed when shooting and during playback may occur when:
  - The flash strobos.
  - The shutter speed is slow or high.
- The histogram may not appear for images recorded using other cameras.
- When you set the LCD screen to Off, the digital zoom does not function (page 46) and [AF Mode] is set to [Single] (page 46). When you select  (flash mode)/ (self-timer)/ (macro), the image is displayed for about two seconds.

- When you set the histogram display to on, image information is displayed during playback.
- The histogram does not appear:
 

When shooting in the following situations

  - The menu is displayed.
  - Recording movies.

During playback in the following situations

  - The menu is displayed.
  - In index mode.
  - You are using playback zoom.
  - You are rotating still images.
  - Playback of movies.

# Number of still images and recording time of movies

The tables show the approximate number of still images and the length of time for movies that can be recorded on a “Memory Stick” formatted with this camera. The values may vary depending on the shooting conditions.

The number of images that can be recorded using this internal memory is equivalent to that of a 32 MB “Memory Stick”.

## The number of still images (The image quality is [Fine] on the upper line and [Standard] on the lower line.) (Images)

Capacity Size	32MB	64MB	128MB	256MB	512MB	1GB	2GB
4M	16	32	65	119	242	494	1012
	30	60	121	216	440	898	1841
3:2	16	32	65	119	242	494	1012
	30	60	121	216	440	898	1841
3M	20	41	82	148	302	617	1266
	37	74	149	264	537	1097	2250
1M	50	101	202	357	726	1482	3038
	93	187	376	649	1320	2694	5524
VGA(E-Mail)	196	394	790	1428	2904	5928	12154
	491	985	1975	3571	7261	14821	30385

- The number of images listed is for when [Mode] is set to [Normal].
- The size of a single still image is 1M when [Mode] is set to [Multi Burst].
- When the number of remaining shootable images is greater than 9,999, the “>9999” indicator appears.
- You can resize the images later ([Resize], (page 41)).

## The recording time of movies (hour : minute : second)

Capacity Size	32MB	64MB	128MB	256MB	512MB	1GB	2GB
640(Fine)	–	–	–	0:02:57	0:06:02	0:12:20	0:25:18
640(Standard)	0:01:27	0:02:56	0:05:54	0:10:42	0:21:47	0:44:27	1:31:09
160	0:22:42	0:45:39	1:31:33	2:51:21	5:47:05	11:44:22	24:18:25

- Movies with the size set to [640(Fine)] can be only recorded on a “Memory Stick PRO”.
- For image size and image quality, see page 13.
- When images recorded using earlier Sony models are played back on this camera, the display may differ from the actual image size.

# When you do not have a “Memory Stick” (Recording with the internal memory)

The camera has 32 MB of internal memory. This memory is not removable. Even when there is no “Memory Stick” inserted in the camera, you can record images using this internal memory.

- Movies with the image size set to [640(Fine)] cannot be recorded using the internal memory.

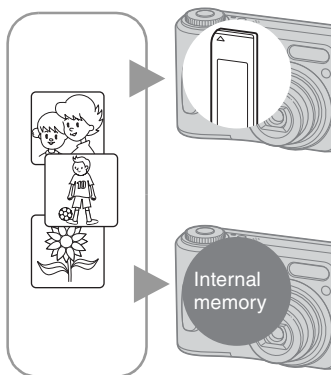

## When a “Memory Stick” (not supplied) is inserted

[Recording]: Images are recorded on the “Memory Stick”.

[Playback]: Images on the “Memory Stick” are played back.

[Menu, Setup, etc.]: Various functions can be performed on images on the “Memory Stick”.

## When there is no “Memory Stick” inserted

[Recording]: Images are recorded using the internal memory.

[Playback]: Images stored in the internal memory are played back.

[Menu, Setup, etc.]: Various functions can be performed on images in the internal memory.

## On image data stored in the internal memory

We recommend that you copy (back up) data without fail using one of the following methods.

### To copy (back up) data on a “Memory Stick”

Prepare a “Memory Stick” with a capacity of 32 MB or more, then perform the procedure explained in [Copy] (page 52).

### To copy (back up) data on a hard disc of your computer

Perform the procedure on pages 58 to 62 without a “Memory Stick” inserted in the camera.

- You cannot move image data on a “Memory Stick” to the internal memory.
- By connecting the camera and a computer with a cable for multi-use terminal (DSC-S90/S80/S60) or Cyber-shot Station (DSC-ST80), you can copy data stored in the internal memory to a computer, but you cannot copy data on a computer to the internal memory.

# Battery life and number of images that can be recorded/viewed

The tables show the approximate number of images that can be recorded/viewed and the battery life when you shoot images in [Normal] mode with batteries at full capacity and at an ambient temperature of 25°C (77°F). The numbers of images that can be recorded or viewed take into account changing the “Memory Stick” as necessary. Note that the actual numbers may be less than those indicated depending on the conditions of use.

- The battery capacity decreases as the number of uses increases and also over time (page 93).
- The number of images that can be recorded/viewed and the battery life are decreased under the following conditions:
  - The surrounding temperature is low
  - The flash is used
  - The camera has been turned on and off many times
  - The zoom is used frequently
  - [LCD Backlight] is set to [Bright]
  - [AF Mode] is set to [Monitor]
  - The battery power is low

## When shooting still images

Battery	LCD screen	No. of images (Approx.)	Battery life (min.) (Approx.)
DSC-S90			
NH-AA-DA (Ni-MH) <sup>*1</sup>	On	420	210
	Off	590	295
Alkaline <sup>*2</sup>	On	80	40
	Off	150	75
Battery pack NP-NH25 <sup>*3</sup>	On	490	245
	Off	700	350
DSC-S80/ST80/S60			
NH-AA-DA (Ni-MH) <sup>*1</sup>	On	440	220
	Off	590	295
Alkaline <sup>*2</sup>	On	100	50
	Off	150	75
Battery pack NP-NH25 <sup>*3</sup>	On	510	255
	Off	700	350

<sup>\*1</sup> Supplied with DSC-S90/DSC-S80

<sup>\*2</sup> Supplied with DSC-S60

<sup>\*3</sup> Supplied with DSC-ST80

- Shooting in the following situations:
  -  (P.Quality) is set to [Fine]
  - [AF Mode] is set to [Single]
  - Shooting once every 30 seconds
  - The zoom is switched alternately between the W and T ends
  - The flash strobes once every two times
  - The power turns on and off once every ten times
- The measurement method is based on the CIPA standard. (CIPA: Camera & Imaging Products Association)
- Number of shooting image does not change depending on the image size.

## When viewing still images

Battery	No. of images (Approx.)	Battery life (min.) (Approx.)
DSC-S90		
NH-AA-DA (Ni-MH) <sup>*1</sup>	9000	450
Alkaline <sup>*2</sup>	5300	260
Battery pack NP-NH25 <sup>*3</sup>	10500	520
DSC-S80/ST80/S60		
NH-AA-DA (Ni-MH) <sup>*1</sup>	10000	500
Alkaline <sup>*2</sup>	7000	350
Battery pack NP-NH25 <sup>*3</sup>	11800	590

<sup>\*1</sup> Supplied with DSC-S90/DSC-S80

<sup>\*2</sup> Supplied with DSC-S60

<sup>\*3</sup> Supplied with DSC-ST80

- Viewing single images in order at about three second intervals

## When shooting movies

Battery	LCD screen On (Approx.)	LCD screen Off (Approx.)
DSC-S90		
NH-AA-DA (Ni-MH)* <sup>1</sup>	210 min.	300 min.
Alkaline* <sup>2</sup>	60 min.	120 min.
Battery pack NP-NH25* <sup>3</sup>	240 min.	360 min.
DSC-S80/ST80/S60		
NH-AA-DA (Ni-MH)* <sup>1</sup>	220 min.	300 min.
Alkaline* <sup>2</sup>	90 min.	120 min.
Battery pack NP-NH25* <sup>3</sup>	260 min.	360 min.

\*<sup>1</sup> Supplied with DSC-S90/DSC-S80

\*<sup>2</sup> Supplied with DSC-S60

\*<sup>3</sup> Supplied with DSC-ST80

- Shooting movies continuously with an image size of [160]



## Scene Selection

For details → *step 5* in “*Read This First*”

For shooting an image appropriately according to the scene condition, a combination of functions is determined by the camera.

(✓: you can select the desired setting)

	Macro	Flash	AF range finder	Focus preset	White Balance	Burst/Multi Burst
	—		✓	∞	✓	—
	✓		✓	✓	Auto	—
	—		Center AF	0.5m/1.0m 3.0m/7.0m		—
	✓		✓	✓	✓	✓
	✓		✓	✓	✓	✓
	—		✓	∞	✓	✓
	✓	✓	✓	✓	✓	✓

## To adjust the exposure manually

- ① Press on the control button when the mode dial is set to M.

The “Set” indicator at the lower left of the screen changes to “Return,” and the camera enters the manual exposure setup mode.

- ② Adjust the settings using the control button.

◀/▶: Aperture (F value)

▲/▼: Shutter speed

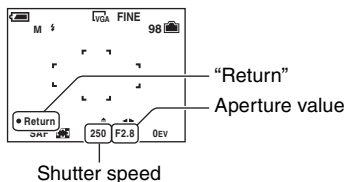

When the zoom is set fully to the W side, you can select an aperture, F2.8 or F5.6.

When the zoom is set fully to the T side, you can select an aperture, F5.2 or F10.

You can select a shutter speed from 1/1000 to 30 seconds.

The difference between the settings and proper exposure judged by the camera appears as an EV value (page 31) on the screen. 0EV indicates the value judged as the most suitable by the camera.

- ③ Shoot the image.

- To use the Quick Review, close-up (Macro), or self-timer function, or to change the flash mode, press to cancel the manual exposure setup mode after step ①. (The “Return” indicator changes to “Set”.)
- The flash is set to (Forced flash) or (No flash).

- Shutter speeds of one second or longer are indicated by ["], for example, 1".
- When you set the shutter speed slower, using a tripod is recommended to prevent the effects of vibration.
- If you select shutter speeds of 1/6 second or slower, the NR slow shutter function activates automatically to reduce the picture noise and "NR" appears.
- If you select slow shutter speeds, it takes time to process the data.

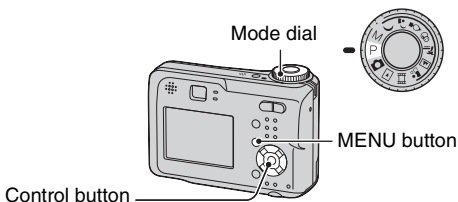
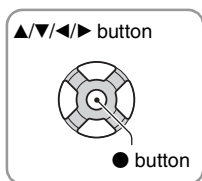

# 1 Turn on the power and set the mode dial.

Items available vary depending on the mode dial position.

# 2 Press MENU to display the menu.

# 3 Select the desired menu item with ◀/▶ on the control button.

- If the desired item is invisible, keep pressing ◀/▶ until it appears on the screen.
- Press ● after selecting an item when the mode dial is set to .

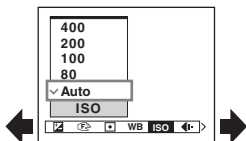

# 4 Select the setting with ▲/▼.



The setting you select is zoomed and is set.

# 5 Press MENU to turn off the menu.











- If there is an item that is not displayed, an ▲/▼ mark appears on the edges of the location where menu items usually appear. To display an item that is not displayed, select the mark with the control button.
- You cannot select items that are grayed out.

✓









Mode dial position:

	P	M	Scene		
---	---	---	-------	---	---

## Menu for shooting (page 31)

 (EV)	—	✓	—	✓	✓	—
 (Focus)	—	✓	✓	✓	✓	—
 (Metering Mode)	—	✓	✓	✓	✓	—
WB (White Bal)	—	✓	✓	✓	✓	—
ISO	—	✓	✓	✓	—	—
 (P.Quality)	—	✓	✓	✓	—	—
Mode (REC Mode)	✓	✓	✓	✓	—	—
 (Interval)	—	✓	✓	✓	—	—
 (Flash Level)	—	✓	✓	✓	—	—
PFX (P.Effect)	—	✓	✓	✓	✓	—
 (Saturation)	—	✓	✓	—	—	—
 (Contrast)	—	✓	✓	—	—	—
 (Sharpness)	—	✓	✓	—	—	—
 (Setup)	✓	✓	✓	✓	✓	—

## Menu for viewing (page 38)

 (Folder)	—	—	—	—	—	✓
 (Protect)	—	—	—	—	—	✓
DPOF	—	—	—	—	—	✓
 (Print)	—	—	—	—	—	✓
 (Slide)	—	—	—	—	—	✓
 (Resize)	—	—	—	—	—	✓
 (Rotate)	—	—	—	—	—	✓
 (Divide)	—	—	—	—	—	✓
 (Setup)	—	—	—	—	—	✓
Trimming	—	—	—	—	—	✓

The default settings are marked with ✓.



Manually adjusts the exposure.

	↑ +2.0EV	Toward +: Brightens an image.
✓	0EV	The exposure is determined automatically by the camera.
	↓ -2.0EV	Toward -: Darkens an image.

- For details on the exposure → page 11
- The compensation value can be set in 1/3EV increments.
- If a subject is being shot in extremely bright or dark conditions, or the flash is used, the exposure adjustment may not be effective.

## Adjusting [EV] by displaying a histogram

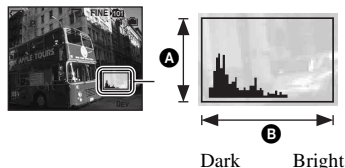



A histogram is a graph showing the brightness of an image. Set the mode dial to P or Scene in advance, then press  $\square$  repeatedly to display the histogram. The graph display indicates a bright image when skewed to the right side, a dark image when skewed to the left side. A histogram can be used to check the exposure and adjust [EV].

- A** Number of pixels
- B** Brightness

- The histogram also appears in the following cases, but you cannot adjust the exposure.
  - When the mode dial is set to  $\square$  or M
  - When playing back a single image
  - During Quick Review

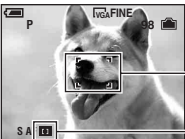

You can change the focus method. Use the menu when it is difficult to get the proper focus in auto focus mode.

	∞ (unlimited distance)	<p>Focuses on the subject using a previously set distance to the subject. (Focus preset)</p> <ul style="list-style-type: none"> <li>When shooting a subject through a net or through window glass, it is difficult to get the proper focus in auto focus mode. In these cases, use of [Focus] is convenient.</li> </ul>
	7.0m	
	3.0m	
	1.0m	
	0.5m	
	Center AF ( <b>[F]</b> )	<p>Focuses automatically on a subject near the center of the frame.</p> <ul style="list-style-type: none"> <li>Using this with the AF lock function lets you shoot in the desired image composition.</li> </ul>  <p>AF range finder frame AF finder frame indicator</p>
✓	Multi AF (Multipoint AF) (Still image <b>[M]</b> ) (Movie <b>[M]</b> )	<p>Focuses automatically on a subject in all ranges of the finder frame.</p> <ul style="list-style-type: none"> <li>This mode is useful when the subject is not in the center of the frame.</li> </ul>  <p>AF range finder frame AF range finder frame indicator</p>

- AF stands for Auto Focus.
- Distance setting information in [Focus] is approximate. If you point the lens up or down, the error increases.
- The distance selection is limited according to the Scene mode (page 27).
- When you are shooting movies, [Multi AF] is recommended as the AF works even with a certain amount of vibration.
- When you use [Digital Zoom] or [AF Illuminator], priority AF movement is given to subjects in or near the center of the frame. In this case the **[M]** or **[M]** indicator flashes and the AF range finder frame is not displayed.

 If the subject is out of focus

When shooting with the subject at the edge of the frame (or the screen), or when using [Center AF], the camera may not focus on a subject at the edge of the frame. In a case like this, do as follows.

- ① Recompose the shot so that the subject is centered in the AF range finder, and press the shutter button halfway down to focus on the subject (AF lock).

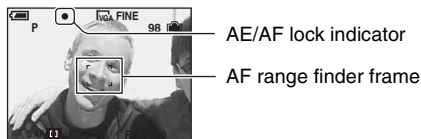



As long as you do not press the shutter button fully down, you can retry the procedure as many times as you want.

- ② When the AE/AF lock indicator stops flashing and remains on, return to the fully composed shot, and press the shutter button fully down.

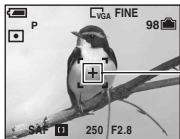

Selects the metering mode that sets which part of the subject to measure to determine the exposure.

<p>Spot (Spot metering) </p>	<p>Measures only a part of the subject.</p> <ul style="list-style-type: none"> <li>This function is useful when the subject is backlit or when there is strong contrast between the subject and the background.</li> </ul>  <p>Spot metering cross hairs Positions on the subject.</p>
<p> Multi (Multi-pattern metering)</p>	<p>Divides into multiple regions and measures each region. The camera determines a well-balanced exposure.</p>

- For details on the exposure → page 11
- When using spot metering, setting [] (Focus) to [Center AF] is recommended to focus on the metering position (page 32).

## WB (White Bal)



Adjusts the color tones according to the lighting condition in a situation, for example, when the colors of a image look strange.

	(Incandescent)	Adjusts for places where the lighting conditions change quickly such as a party hall, or under bright lighting such as photography studios.
	(Fluorescent)	Adjusts for fluorescent lighting.
	(Cloudy)	Adjusts for a cloudy sky.
	(Daylight)	Adjusts for outdoors, shooting night scenes, neon signs, fireworks, or sunrise, or conditions before and after sundown.
<input checked="" type="checkbox"/>	Auto	Adjusts the White Balance automatically.

- For details on [WB] → page 12
- Under fluorescent lights that flicker, the white balance function may not work correctly even though you select (Fluorescent).

## ISO



Selects a luminous sensitivity with units of ISO. The larger the number, the higher the sensitivity.

<input type="checkbox"/>	400	Select a large number when shooting in dark locations or shooting a subject moving at high speed, or select a small number to obtain high image quality.
<input type="checkbox"/>	200	
<input type="checkbox"/>	100	
<input type="checkbox"/>	80	
<input checked="" type="checkbox"/>	Auto	

- For details on the [ISO] sensitivity → page 12
- Note that the image tends to become noisier as the ISO sensitivity number increases.
- [ISO] is set to [Auto] in the Scene mode.

## P (P. Quality)



Selects the still image quality.

<input checked="" type="checkbox"/>	Fine (FINE)	Records with high quality (low compression).
<input type="checkbox"/>	Standard (STD)	Records with standard quality (high compression).

- For details on the image quality → page 13



The maximum number of continuous shots

(Units: images)

Size \ Quality	Fine	Standard
4M	4	6
3:2	4	6
3M	4	7
1M	10	18
VGA(E-Mail)	30	30



Selects the frame interval in the [Multi Burst] mode (page 35).

<input type="checkbox"/>	1/7.5 (1/7.5")	• This setting cannot be made when [Mode] (REC Mode) in the menu is set to other than [Multi Burst] (page 35).
<input type="checkbox"/>	1/15 (1/15")	
<input checked="" type="checkbox"/>	1/30 (1/30")	



Adjusts the amount of flash light.

<input type="checkbox"/>	+ (⚡+)	Toward +: Makes the flash level higher.
<input checked="" type="checkbox"/>	Normal	
<input type="checkbox"/>	- (⚡-)	Toward -: Makes the flash level lower.

• To change flash mode → step 5 in “Read This First”



Allows you to shoot an image with special effects.

<input type="checkbox"/>	B & W (P+) )	Records the image in monochrome (black and white).
<input type="checkbox"/>	Sepia (P+) )	Records the image in sepia (like an old photograph).
<input checked="" type="checkbox"/>	Off	No effect.

• This setting is not maintained when the power is turned off.

**(Saturation)**

Adjusts the saturation of the image.

	+ (☉)	Toward +: Brightens the color.
✓	Normal	
	- (☉)	Toward -: Darkens the color.

**(Contrast)**

Adjusts the contrast of the image.

	+ (☉)	Toward +: Enhances the contrast.
✓	Normal	
	- (☉)	Toward -: Reduces the contrast.

**(Sharpness)**

Adjusts the sharpness of the image.

	+ (⌘)	Toward +: Sharpens the image.
✓	Normal	
	- (⌘)	Toward -: Softens the image.

**(Setup)**

See page 45.

The default settings are marked with ✓.



Selects the folder containing the image you want to play back (when using a “Memory Stick” only).

	OK	See the following procedure.
✓	Cancel	Cancels the selection.

① Select the desired folder with ◀/▶ on the control button.

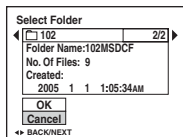

② Select [OK] with ▲, then press ●.

## 💡 On the [Folder]

The camera stores images in a specified folder of a “Memory Stick” (page 51). You can change the folder or create a new one.

- To create a new folder → [Create REC. Folder] (page 51)
- To change the folder for recording images → [Change REC. Folder] (page 52)
- When multiple folders are created in the “Memory Stick” and the first or last image in the folder is displayed, the following indicators appear.

◀: Moves to the previous folder.

▶: Moves to the next folder.

◀▶: Moves to either the previous and next folders.



Protects images against accidental erasure.

✓	Protect (🔑)	See the following procedure.
	Exit	Exits the Protection function.

### To protect images in single-image mode

- ① Display the image you want to protect.
- ② Press MENU to display the menu.
- ③ Select [🔑] (Protect) with ◀/▶ on the control button, then press ●.  
The image is protected and the 🔑 (protect) indicator appears on the image.



- ④ To protect other images, select the desired image with ◀/▶, then press ●.

### To protect images in index mode

- ① Press [📄] (index) to display the index screen.
- ② Press MENU to display the menu.
- ③ Select [🔑] (Protect) with ◀/▶ on the control button, then press ●.
- ④ Select [Select] with ▲/▼, then press ●.
- ⑤ Select the image you want to protect with ▲/▼/◀/▶, then press ●.  
A green 🔑 indicator appears on the selected image.

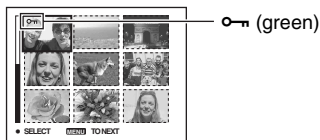

- ⑥ Repeat step ⑤ to protect other images.
  - ⑦ Press MENU.
  - ⑧ Select [OK] with ▶, then press ●.  
The 🔑 indicator turns white. The selected images are protected.
- To protect all images in the folder, select [All In This Folder] in step ④, and press ●. Select [On] with ▶, then press ●.

## To cancel the protection

In single-image mode

Press ● in step ③ or ④ of “To protect images in single-image mode.”

In index mode

- ① Select the image for which you want to remove protection in step ⑤ of “To protect images in index mode.”
- ② Press ● to turn the  indicator gray.
- ③ Repeat the operation above for all images to be unprotected.
- ④ Press MENU, select [OK] with ►, and then press ●.

## To cancel protection of all images in the folder

Select [All In This Folder] in step ④ of “To protect images in index mode,” and press ●. Select [Off] with ►, then press ●.

- Note that formatting the recording media erases all the data stored on it, even if images are protected, and these images cannot be recovered.
- It may take some time to protect an image.



Adds a  (Print order) mark to images you want to print (page 73).



See page 70.



Plays back recorded images in order (Slide show).

## Interval

<input checked="" type="checkbox"/>	3 sec	Sets the slide show interval.
<input type="checkbox"/>	5 sec	
<input type="checkbox"/>	10 sec	
<input type="checkbox"/>	30 sec	
<input type="checkbox"/>	1 min	

**Image**

<input checked="" type="checkbox"/>	Folder	Plays back all images in the selected folder.
<input type="checkbox"/>	All	Plays back all images stored on the “Memory Stick”.

**Repeat**

<input checked="" type="checkbox"/>	On	Plays back images in a continuous loop.
<input type="checkbox"/>	Off	After all the images have been played back, the slide show ends.

<input type="checkbox"/>	Start	See the following procedure.
<input checked="" type="checkbox"/>	Cancel	Cancels the slide show.

① Select [Interval], [Image] and [Repeat] with ▲/▼/◀/▶ on the control button.

② Select [Start] with ▼/▶, then press ●.  
The slide show starts.

To end the slide show, press ●, select [Exit] with ▶, then press ●.

- During a slide show, you can display the previous/next image with ◀/▶.
- The [Interval] time is just a guideline, so it may vary depending on the image size, etc.



You can change the image size of a recorded image (Resize), and save it as a new file. The original image is retained even after resizing.

<input type="checkbox"/>	4M	The setting size is just a guideline. → step 4 in “Read This First”
<input type="checkbox"/>	3M	
<input type="checkbox"/>	1M	
<input type="checkbox"/>	VGA	
<input checked="" type="checkbox"/>	Cancel	Cancels resizing.

① Display the image you want to resize.

② Press MENU to display the menu.

③ Select [(Resize)] (Resize) with ◀/▶, then press ●.

④ Select the desired size with ▲/▼, then press ●.  
The resized image is recorded in the recording folder as the newest file.

- For details on [Image Size] → step 4 in “Read This First”
- You cannot change the size of movies or [Multi Burst] images.
- When you change from a small size to a large size, the image quality deteriorates.
- You cannot resize to an image size of 3:2.
- When you resize a 3:2 image, the upper and lower black portions will be displayed on the image.



Rotates a still image.

		Rotates an image. See the following procedure.
	OK	Determines the rotation. See the following procedure.
✓	Cancel	Cancels rotation.

- ① Display the image to be rotated.
- ② Press MENU to display the menu.
- ③ Select [] (Rotate) with ◀/▶ on the control button, then press ●.
- ④ Select [] with ▲, then rotate the image with ◀/▶.
- ⑤ Select [OK] with ▲/▼, then press ●.

- You cannot rotate protected images, movies, or [Multi Burst] images.
- You may not be able to rotate images shot with other cameras.
- When viewing images on a computer, the image rotation information may not be reflected depending on the software.



Cuts movies, or deletes unnecessary portions of movies. This is the recommended function to use when the internal memory or “Memory Stick” capacity is insufficient, or when you attach movies to your e-mail messages.

- Note that the original movie is deleted and that number is skipped. Also note that you cannot restore files once you cut them.

	OK	See the following procedure.
✓	Cancel	Cancels division.

**Example: Cutting a movie numbered 101\_0002**

This section describes an example of dividing a movie numbered 101\_0002 and deleting it in the following file configuration.

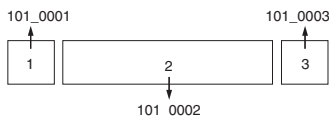
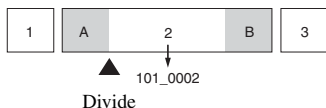
**1 Cutting scene A.**

101\_0002 is divided into 101\_0004 and 101\_0005.

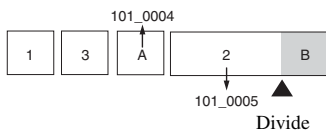
**2 Cutting scene B.**

101\_0005 is divided into 101\_0006 and 101\_0007.

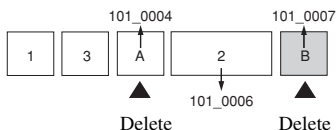
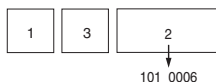
**3 Deleting scenes A and B if they are unnecessary.****4 Only the desired scenes remain.****Procedure**

- ① Display the movie to be divided.
- ② Press MENU to display the menu.
- ③ Select [Divide] with ◀▶ on the control button, then press ●.
- ④ Select [OK] with ▲, then press ●.  
The playback of the movie starts.

- ⑤ Press ● at the desired cutting point.

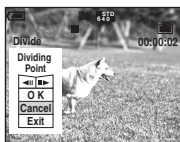

- When you want to adjust the cutting point, select [◀||▶] (frame rewind/forward) and adjust the cutting point using ◀/▶.
- If you want to change the cutting point, select [Cancel]. The playback of the movie starts again.

- ⑥ Select [OK] with ▲/▼, and press ●.

- ⑦ Select [OK] with ▲, then press ●.  
The movie is cut.

- The cut movies are assigned new numbers, and then recorded as the newest files in the selected recording folder.
- You cannot cut the following kinds of images.
  - Still image
  - Movies not long enough to cut (shorter than about two seconds)
  - Protected movies (page 39)



See page 45.



Records an enlarged image (→ step 6 in “Read This First”) as a new file.

	Trimming	See the following procedure.
✓	Return	Cancels trimming.

- ① Press MENU during playback zoom to display the menu.
- ② Select [Trimming] with ▶ on the control button, then press ●.
- ③ Select the image size with ▲/▼, then press ●.  
The image is recorded, and the original image is displayed again.

- The trimmed image is recorded as the newest file in the selected recording folder, and the original image is retained.
- The quality of trimmed images may deteriorate.
- You cannot trim to an image size of 3:2.
- You cannot trim images displayed with Quick Review.



# Using Setup items

You can change the default settings using the Setup screen.

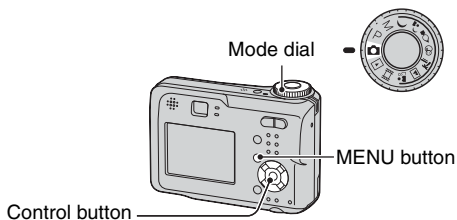
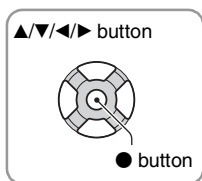

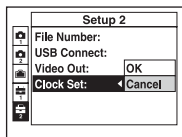

- 1 Turn on the power.
- 2 Press MENU to display the menu.
- 3 Press ► on the control button to select  (Setup).
- 4 Press ▲/▼/◀/▶ on the control button to select the item you want to set.

The frame of the selected item turns yellow.

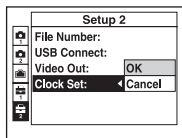

- 5 Press ● to enter the setting.



To turn off the  (Setup) screen, press MENU.

## To cancel the (Setup) setting

Select [Cancel] if it appears, then press ● on the control button. If it does not appear, select the previous setting again.

- This setting is maintained even when the power is turned off.

The default settings are marked with ✓.

## AF Mode

Selects the auto focus operation mode.

✓	Single (S AF)	Automatically adjusts the focus when the shutter button is pressed and held halfway down. This mode is useful for shooting stationary subjects.
	Monitor (M AF)	Automatically adjusts the focus before the shutter button is pressed and held halfway down. This mode shortens the time needed for focusing. <ul style="list-style-type: none"> <li>• Battery consumption is faster than in [Single] mode.</li> </ul>

- When shooting using the finder with the LCD screen off, the camera operates in the [Single] mode.

## Digital Zoom

Selects the digital zoom mode. The camera enlarges the image using optical zoom (up to 3×). When the zoom scale exceeds 3×, the camera uses either smart or precision digital zoom.

✓	Smart (Smart zoom) (SQx)	Enlarges the image digitally with almost no distortion. This is not available when the image size is set to [4M] or [3:2]. <ul style="list-style-type: none"> <li>• The maximum zoom scale of Smart zoom is shown in the following table.</li> </ul>
	Precision (Precision digital zoom) (PQx)	Enlarges all image sizes up to a maximum of 6×, but the image quality deteriorates.
	Off (x)	Does not use the digital zoom.

Image size and maximum zoom scale using Smart zoom

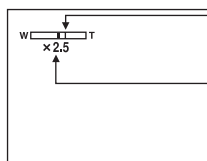

Size	Maximum zoom scale
4M	—
3M	Approx. 3.4×
1M	Approx. 5.4×
VGA(E-Mail)	Approx. 10×

- When you press the zoom button, the zoom scaling indicator appears as follows.



The W side of this line is the optical zoom area, and the T side is the digital zoom area

Zoom scaling indicator

- The maximum zoom scale of smart zoom/precision zoom includes the scale of the optical zoom.
- The AF range finder frame does not appear when using the digital zoom. The  or  indicator flashes, and AF operates with priority on subjects located near the center of the frame.
- When using the smart zoom, the image on the screen may look rough. However, this phenomenon has no effect on the recorded image.

## Date/Time

Selects how to superimpose the date or time onto the image. Select this before shooting.

- The date and time do not appear during shooting, instead, the  indicator appears. The date and time appear in red on the lower-right corner of the screen during playback only.

<input type="checkbox"/>	Day&Time	Superimposes the date, hour, and minute.
<input type="checkbox"/>	Date	Superimposes the year, month and day. <ul style="list-style-type: none"> <li>The date is inserted in the order you select. (→ step 2 “Set the clock” in “Read This First”)</li> </ul>
<input checked="" type="checkbox"/>	Off	Does not superimpose the date and time.

- You cannot insert the date and time into movies or images in the [Multi Burst] mode.
- The date and time superimposed cannot be removed later.

## Red Eye Reduction



Reduces the red-eye phenomenon when using the flash. Select this before shooting.





<input type="checkbox"/>	On 	Reduces the red-eye phenomenon. <ul style="list-style-type: none"> <li>The flash pre-strobes twice or more before shooting.</li> </ul>
<input checked="" type="checkbox"/>	Off	Does not use Red Eye Reduction.

- Because it takes about a second until the shutter clicks, hold the camera firmly to prevent the effects of vibration. Also, do not let the subject move.
- Red-eye reduction may not produce the desired effects depending on individual differences, the distance to the subject, if the subject does not see the pre-strobe, or other conditions.

## AF Illuminator

The AF illuminator supplies fill light to focus more easily on a subject in dark surroundings. The AF illuminator emits red light allowing the camera to focus easily when the shutter button is pressed halfway, until the focus is locked. The **AF-ON** indicator appears at this time.

✓	Auto	Uses the AF illuminator.
	Off	Does not use AF illuminator.

- If the AF illuminator light does not reach the subject sufficiently or the subject has no contrast, focus will not be achieved. (A distance of up to approximately 3.5 m (137 7/8 inches) (W)/2.5 m (98 1/2 inches) (T) is recommended.)
- Focus is achieved as long as the AF illuminator light reaches the subject, even if the light is slightly off the center of the subject.
- When Focus preset is set (page 32), [AF Illuminator] does not function.
- The AF range finder frame does not appear. The  or  indicator flashes, and AF operates with priority on subjects located near the center of the frame.
- The AF illuminator does not operate when  (Twilight mode) or  (Landscape mode) is selected in the Scene mode.
- The AF illuminator emits very bright light. Although there are no problems with safety, do not look directly into the AF illuminator emitter at close range.

## Auto Review

Displays the recorded image on the screen for approximately two seconds immediately after shooting a still image.

✓	On	Use the Auto Review.
	Off	Does not use Auto Review.

- You cannot shoot the next image during the Auto Review display. If you press the shutter button halfway down during this period, the recorded image display disappears and you can immediately shoot the next image.

The default settings are marked with ✓.

### Enlarged Icon

Enlarges the setting indicator temporarily when you press ⚡ (Flash mode), ⌚ (Self-timer), or 🌸 (Macro).

✓	On	Enlarges the indicators.
	Off	Does not enlarge the indicators.



This item does not appear when a “Memory Stick” is inserted in the camera.  
The default settings are marked with ✓.

## Format

Formats the internal memory.

- Note that formatting irrevocably erases all data in the internal memory, including even protected images.

	OK	See the following procedure.
✓	Cancel	Cancels the formatting.

- ① Select [OK] with ▲ on the control button, then press ●.  
The message “All data in internal memory will be erased Ready?” appears.
- ② Select [OK] with ▲, then press ●.  
The format is complete.

This item appears only when a “Memory Stick” is inserted in the camera.  
The default settings are marked with ✓.

## Format

Formats the “Memory Stick”. A commercially available “Memory Stick” is already formatted, and can be used immediately.

- Note that formatting irrevocably erases all data on a “Memory Stick”, including even protected images.

	OK	See the following procedure.
✓	Cancel	Cancels the formatting.

- ① Select [OK] with ▲ on the control button, then press ●.  
The message “All data in Memory Stick will be erased Ready?” appears.
- ② Select [OK] with ▲, then press ●.  
The format is complete.

## Create REC. Folder

Creates a folder in a “Memory Stick” for recording images.

	OK	See the following procedure.
✓	Cancel	Cancels folder creation.

- ① Select [OK] with ▲ on the control button, then press ●.  
The folder creation screen appears.

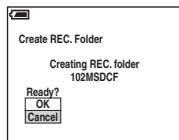

- ② Select [OK] with ▲, then press ●.  
A new folder is created with a number incremented one higher than the largest number, and the folder becomes the current recording folder.

- For details on the folder, see page 38.
- When not creating a new folder, the “101MSDCF” folder is selected as the recording folder.
- You can create folders designated up to “999MSDCF.”
- Images are recorded in the newly created folder until a different folder is created or selected.
- You cannot delete a folder with the camera. To delete a folder, use your computer, etc.
- Up to 4,000 images can be stored in one folder. When the folder capacity is exceeded, a new folder is automatically created.
- For more information, see “Image file storage destinations and file names” (page 63).

## Change REC. Folder

Changes the folder currently used for recording images.

	OK	See the following procedure.
✓	Cancel	Cancels changing the recording folder.

- ① Select [OK] with ▲ on the control button, then press ●.  
The folder selection screen appears.

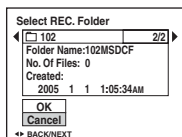

- ② Select the desired folder with ◀/▶, and [OK] with ▲, then ●.
  - You cannot select the “100MSDCF” folder as a recording folder.
  - You cannot move recorded images to a different folder.

## Copy

Copies all images in the internal memory to a “Memory Stick”.

	OK	See the following procedure.
✓	Cancel	Cancels the copying.

- ① Insert a “Memory Stick” having 32 MB or larger capacity.
- ② Select [OK] with ▲ on the control button, then press ●.  
The message “All data in internal memory will be copied Ready?” appears.
- ③ Select [OK] with ▲, then press ●.  
Copying starts.

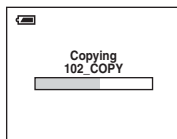

- Use batteries with enough capacity or the AC Adaptor (not supplied). If you attempt to copy image files using batteries with little remaining charge, the batteries may run out, causing copying to fail or possibly corrupting the data.
- You cannot copy individual images.
- The original images in the internal memory are retained even after copying. To delete the contents of the internal memory, remove the “Memory Stick” after copying, then execute the [Format] command in Internal Memory Tool (page 50).
- You cannot select a folder copied on a “Memory Stick”.
- The setting of (Print order) marks is not copied even when you copy data.

The default settings are marked with ✓.

### LCD Backlight

Selects the brightness of the LCD backlight when using the camera with batteries.

	Bright	Brightens.
✓	Normal	
	Dark	Darkens.

- Selecting [Bright] uses up the battery charge faster.

### Beep

Selects the sound produced when you operate the camera.

	Shutter	Turns on the shutter sound when you press the shutter button.
✓	On	Turns on the beep/shutter sound when you press the control button/ press the shutter button.
	Off	Turns off the beep/shutter sound.

### Language

Selects the language to be used to display the menu items, warnings, and messages.

### Initialize

Initializes the setting to the default setting.

	OK	See the following procedure.
✓	Cancel	Cancels the resetting.

- ① Select [OK] with ▲ on the control button, then press ●.  
The message “Initialize all settings Ready?” appears.
  - ② Select [OK] with ▲, then press ●.  
The settings are reset to the default setting.
- Make sure that the power is not disconnected during resetting.

The default settings are marked with ✓.

### File Number

Selects the method used to assign file numbers to images.

✓	Series	Assigns numbers to files in sequence even if the recording folder or the “Memory Stick” is changed. (When the replaced “Memory Stick” contains a file with a number higher than the last assigned number, a number one higher than the largest number is assigned.)
	Reset	Starts from 0001 each time the folder is changed. (When the recording folder contains a file, a number one higher than the largest number is assigned.)

### USB Connect

Selects the USB mode to be used when connecting the camera to a computer or a PictBridge compliant printer using the cable for multi-use terminal (DSC-S90/S80/S60) or Cyber-shot Station (DSC-ST80).

	PictBridge	Connects the camera to a PictBridge compliant printer (page 70).
	PTP	When [PTP] (Picture Transfer Protocol) is set and the camera is connected to a computer, the images in the recording folder selected by the camera are copied to the computer. (Compatible with Windows XP and Mac OS X.)
✓	Normal	Connects the camera to a computer (page 59).

### Video Out

Sets the video signal output according to connected equipment.

	NTSC	Sets the video output signal to NTSC mode (e.g., for the USA, Japan).
	PAL	Sets the video output signal to PAL mode (e.g., for Europe).

**Clock Set**

Sets the date and time.

	OK	Select [OK] with ▲ on the control button, and press ●. Then, perform the procedure explained in “Set the clock” (→ <i>step 2 in “Read This First”</i> ).
✓	Cancel	Cancels setting the clock.



For details on using a Macintosh computer, refer to “Using your Macintosh computer” (page 67).



## Copying images to your computer (page 58)



Viewing images on your computer

## Preparation

Installing the USB driver.

- Installation of the USB driver is not needed when using Windows XP.

## Enjoying images using “PicturePackage” (page 65)



Viewing images saved on your computer



Storing images on a CD-R



Creating a Music video/ Slideshow



Printing images

Installing “PicturePackage” (page 65).

## Creating a video CD using “ImageMixer” (page 65)



Creating a video CD

“ImageMixer VCD2” is installed automatically when “PicturePackage” is installed.

## Recommended computer environment

The following environment is recommended for a computer connected to the camera.

### Recommended environment for copying images

**OS (pre-installed):** Microsoft Windows 98, Windows 98SE, Windows 2000 Professional, Windows Millennium Edition, Windows XP Home Edition, or Windows XP Professional

- Operation is not assured in an environment based on an upgrade of the operating systems described above or in a multi-boot environment.

**CPU:** MMX Pentium 200 MHz or faster

**USB connector:** Provided as standard

**Display:** 800 × 600 dots or more, High Color (16-bit color, 65,000 colors) or more

### Recommended environment for using “PicturePackage”/“ImageMixer VCD2”

**Software:** Macromedia Flash Player 6.0 or later, Windows Media Player 7.0 or later, DirectX 9.0b or later

**Sound card:** 16-bit stereo sound card with speakers

**Memory:** 64 MB or more (128 MB or more is recommended.)

**Hard Disk:** Disk space required for installation—approximately 500 MB

**Display:** Video card (Direct Draw driver compliant) with 4 MB of VRAM

- For automatic creation of a Music video/ Slideshow (page 65), a Pentium III 500 MHz or faster CPU is required.
- When using “ImageMixer VCD2,” a Pentium III 800 MHz or faster CPU is recommended.
- This software is compatible with DirectX technology. “DirectX” must be installed for use.

- A separate software application for operating the recording device is required in order to write to CD-Rs.

### Notes on connecting your camera to a computer

- Operations are not guaranteed for all the recommended computer environments mentioned above.
- If you connect two or more USB devices to a single computer at the same time, some devices, including your camera, may not operate, depending on the types of USB devices you are using.
- Operations are not guaranteed when using a USB hub.
- Connecting your camera using a USB interface that is compatible with Hi-Speed USB (USB 2.0 compliant) allows advanced transfer (high speed transfer) as this camera is compatible with Hi-Speed USB (USB 2.0 compliant).
- There are two modes for a USB connection when connecting a computer, [Normal] (default setting) and [PTP] modes. This section describes the [Normal] mode as an example. For details on [PTP], see page 54.
- When your computer resumes from the suspend or sleep mode, communication between your camera and your computer may not recover at the same time.

# Copying images to your computer

This section describes the process using a Windows computer as an example. You can copy images from the camera to your computer as follows.

## For a computer with a “Memory Stick” slot

Remove the “Memory Stick” from the camera and insert the “Memory Stick” into the “Memory Stick” slot of the computer, then copy the images.

## For a computer without a “Memory Stick” slot

Follow Stages 1 through 5 on pages 58 to 62 to copy images.

- Screens when copying images on a “Memory Stick” to a computer are used as examples.

### Stage 1: Installing the USB Driver

98 98SE 2000 Me

- A driver is software that enable equipment connected to the computer to operate properly.
- When using Windows XP, start from Stage 2.
- When “PicturePackage” is already installed, Stage 1 is unnecessary.



**NOTE: Do not connect the camera to the computer at this time.**

## 1 Shut down all application software in use.

- In Windows 2000, log on as Administrator (authorized Administrators).

## 2 Insert the CD-ROM into the computer, then click [USB Driver] when the install menu screen appears.

The “InstallShield Wizard” screen appears.

- If the install menu screen does not appear, double-click  (My Computer) →  (PICTUREPACKAGE).

## 3 Click [Next].



The USB driver installation starts. When the installation is finished, the screen informs you of completion.

## 4 Click the radio button next to [Yes, I want to restart my computer now] to select it, then click [Finish].

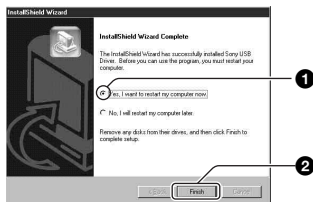

Your computer restarts. Now, you can establish a USB connection.

Remove the CD-ROM when the installation is completed.

## Stage 2: Preparing the camera and the computer

### 1 Insert a “Memory Stick” with recorded images into the camera.

- When copying images in the internal memory, this step is unnecessary.

### 2 Insert the batteries with enough capacity remained in the camera, or connect the camera to a wall outlet (wall socket) with the AC Adaptor (not supplied).

- When you copy images to your computer using insufficient batteries, copying may fail or image data may be corrupted if the batteries shut off too soon.
- For DSC-ST80, also refer to the operating instructions “Cyber-shot Station”.

### 3 Set the mode dial to , then turn on the camera and the computer.

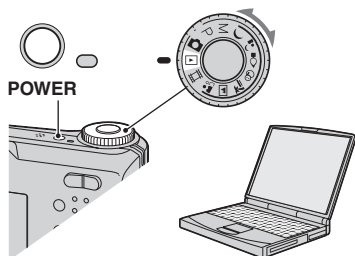

## Stage 3: Connecting the camera and your computer

- For DSC-ST80, also refer to the operating instructions “Cyber-shot Station”.

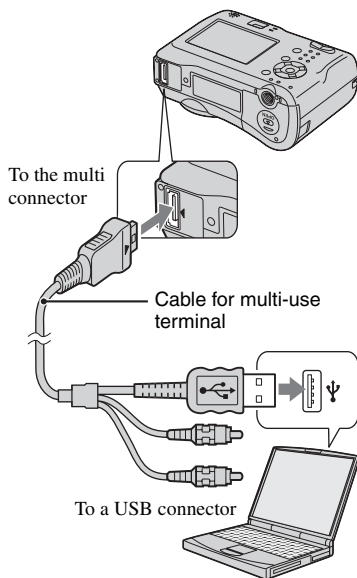

- With Windows XP, the AutoPlay wizard appears on the desktop.

“USB Mode Normal” appears on the screen of the camera.

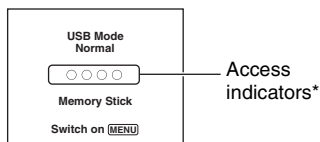

When a USB connection is established for the first time, your computer automatically runs a program to recognize the camera. Wait for a while.

\* During communication, the access indicators turn red. Do not operate the computer until the indicators turn white.

- If “USB Mode Normal” does not appear, set [USB Connect] to [Normal] (page 54).

## Stage 4-A: Copying images to a computer

XP

- For Windows 98/98SE/2000/Me, follow the procedure explained in “Stage 4-B: Copying images to a Computer” on page 61.

This section describes an example of copying images to a “My Documents” folder.

- 1** After making a USB connection in Stage 3, click [Copy pictures to a folder on my computer using Microsoft Scanner and Camera Wizard] → [OK] as the wizard screen appears automatically on the desktop.

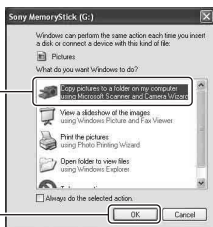

The “Scanner and Camera Wizard” screen appears.

- 2** Click [Next].

The images saved on the “Memory Stick” of the camera appear.

- If no “Memory Stick” is inserted, images in the internal memory appear.

- 3** Click the check box of unwanted images to remove the checkmark so they are not copied, then click [Next].

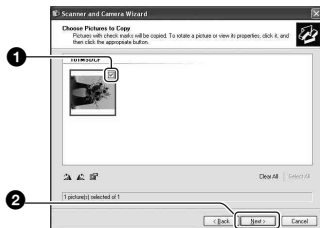

The “Picture Name and Destination” screen appears.

- 4** Select a name and destination for the images, then click [Next].

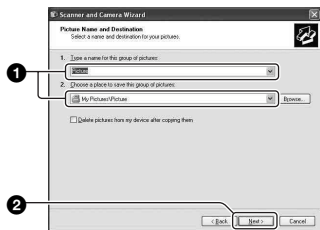
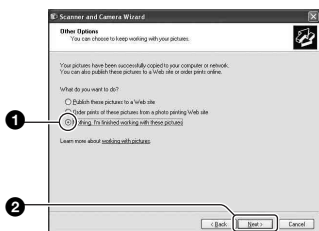

Image copying starts. When the copying is completed, the “Other Options” screen appears.

- This section describes an example of copying images to the “My Documents” folder.

- Click the radio button next to [Nothing, I'm finished working with these pictures] to select it, then click [Next].



The “Completing the Scanner and Camera Wizard” screen appears.

- Click [Finish].

The wizard screen closes.

- To continue copying other images, disconnect the cable for multi-use terminal (DSC-S90/S80/S60) or Cyber-shot Station (DSC-ST80) (page 63) and reconnect it. Then follow the procedure explained in “Stage 3: Connecting the camera and your computer” on page 59.

## Stage 4-B: Copying images to a Computer

98 98SE 2000 Me

- For Windows XP, follow the procedure explained in “Stage 4-A: Copying images to a computer” on page 60.

This section describes an example of copying images to the “My Documents” folder.

- Double-click [My Computer] → [Removable Disk] → [DCIM].

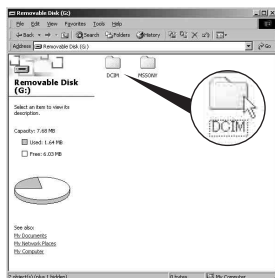

- If the “Removable Disk” icon is not displayed, see page 83.

- Double-click the folder where the image files you want to copy are stored. Then, right-click an image file to display the menu and click [Copy].

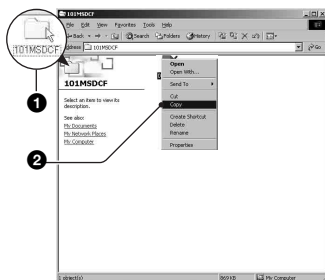

- On the storage destination of the image files, see page 63

**3** Double-click the [My Documents] folder. Then, right-click on the “My Documents” window to display the menu and click [Paste].

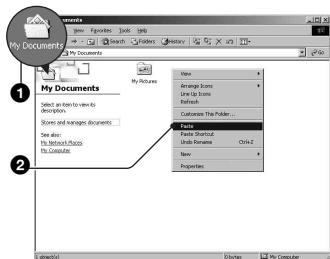

The image files are copied to the “My Documents” folder.

- When an image with the same file name exists in the copy destination folder, the overwrite confirmation message appears. When you overwrite an existing image with a new one, the original file data is deleted. To copy an image file to the computer without overwriting, change the file name to a different name and then copy the image file. However, note that if you change the file name, you may not be able to play back that image with your camera (page 64).

### Stage 5: Viewing images on your computer

This section describes the procedure for viewing copied images in the “My Documents” folder.

**1** Click [Start] → [My Documents].



The contents of the “My Documents” folder are displayed.

- If you are not using Windows XP, double-click [My Documents] on the desktop.

**2** Double-click the desired image file.

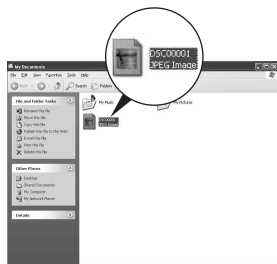

The image is displayed.

### To delete the USB connection

- For DSC-ST80, also refer to the operating instructions “Cyber-shot Station”.
- Perform the following procedure when:
- Disconnecting the cable for multi-use terminal
  - Removing a “Memory Stick”
  - Inserting a “Memory Stick” after copying images from the internal memory
  - Turning off the camera

## ■ For Windows 2000/Me/XP

- 1 Double-click  on the tasktray.



Double-click here

- 2 Click  (Sony DSC) → [Stop].
- 3 Confirm the device on the confirmation window, then click [OK].
- 4 Click [OK].
  - Step 4 is unnecessary for Windows XP.
- 5 Disconnect the cable for multi-use terminal, remove the “Memory Stick”, or turn off the camera. When you copy images from a “Memory Stick” after copying images in the internal memory to the computer, insert the “Memory Stick”.

## ■ For Windows 98/98SE

- 1 Confirm that the access indicators (page 59) are white.
- 2 Disconnect the cable for multi-use terminal, remove the “Memory Stick”, or turn off the camera. When you copy images from a “Memory Stick” after copying images in the internal memory to the computer, insert the “Memory Stick”.

### Image file storage destinations and file names

The image files recorded with your camera are grouped as folders on the “Memory Stick”.

## Example: viewing folders on Windows XP

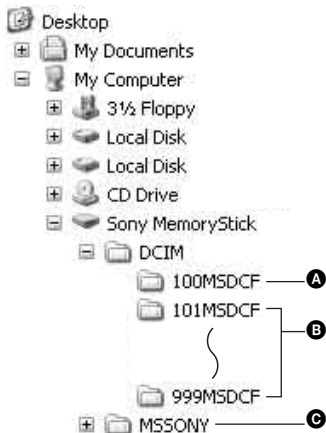

- A** Folder containing image data recorded using a camera not equipped with the folder creating function
  - B** Folder containing image data recorded using this camera  
When not creating any new folders, there is only the “101MSDCF” folder. There is only the “101\_SONY” folder in case of the internal memory.
  - C** Folder containing movie data, etc., recorded using a camera not equipped with the folder creating function
- You cannot record any images to the “100MSDCF” or “MSSONY” folders. The images in these folders are available only for viewing.
  - For more information about folders, see pages 38, 51.
  - Image files are named as follows. □□□□ stands for any number within the range from 0001 to 9999. The numerical portions of the name of a movie file recorded in movie mode and its corresponding index image file are the same.
    - Still image files: DSC0□□□□.JPG
    - Movie files: MOV0□□□□.MPG
    - Index image files that are recorded when you record movies: MOV0□□□□.THM

# Viewing image files stored on a computer with your camera (using a “Memory Stick”)

This section describes the process using a Windows computer as an example.

When an image file copied to a computer no longer remains on a “Memory Stick”, you can view that image again on the camera by copying the image file on the computer to a “Memory Stick”.

- Step 1 is not necessary if the file name set with your camera has not been changed.
- You may be unable to play back some images depending on the image size.
- When an image file has been processed by a computer or when the image file was recorded using a model other than that of your camera, playback on your camera is not guaranteed.
- When there is no folder, first create a folder with your camera (page 51) and then copy the image file.

## 1 Right-click the image file, then click [Rename]. Change the file name to “DSC0□□□□.”

Enter a number from 0001 to 9999 for □□□□.



- If the overwrite confirmation message appears, enter a different number in step 1.
- An extension may be displayed depending on the computer settings. The extension for still images is JPG, and the extension for movies is MPG. Do not change the extension.

## 2 Copy the image file to the “Memory Stick” folder in the following order.

- ① Right-click the image file, then click [Copy].
- ② Double-click [Removable Disk] or [Sony MemoryStick] in [My Computer].
- ③ Right-click the [□□□MSDCF] folder in the [DCIM] folder, then click [Paste].
  - □□□ stands for any number within the range from 100 to 999.

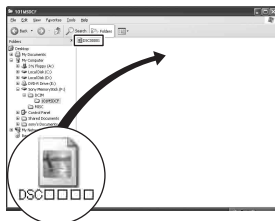

# Using the supplied software

This section describes the process using a Windows computer as an example.

## Overview of the supplied software

The supplied CD-ROM contains two software applications: “PicturePackage” and “ImageMixer.”

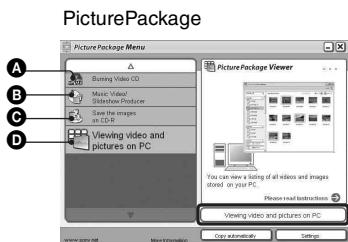

What you can do:

- A** Burning Video CD  
The “ImageMixer VCD2” screen appears.
- B** Music Video/Slideshow Producer
- C** Save the images on CD-R
- D** Viewing video and pictures on PC

How to start up the functions:

Click one of **A-D**, then click the button at the lower right of the screen.



## Installing the software

You can install the “PicturePackage” and “ImageMixer VCD2” software using the following procedure.

- If you have not yet installed the USB driver (page 58), do not connect the camera to the computer before you install the “PicturePackage” software (except for Windows XP).
- In Windows 2000/XP, log on as Administrator.
- When “PicturePackage” is installed, the USB driver is installed automatically.

## 1 Turn on your computer, and insert the CD-ROM (supplied) into the CD-ROM drive.

The installation menu screen appears.

- If it does not appear, double-click  (My Computer) →  (PICTUREPACKAGE).

## 2 Click [PicturePackage].

The “Choose Setup Language” screen appears.

## 3 Select the desired language, then click [Next] twice.

This section describes the English screen.

The “License Agreement” screen appears.

Read the agreement carefully. If you accept the terms of the agreement, click the radio button next to [I accept the terms of the license agreement] and then click [Next].

## 4 Follow the instructions on the screen to complete the installation.

- “ImageMixer VCD2” and “DirectX” will be installed if you have not yet installed them.
- When the restarting confirmation message appears, restart the computer following the instructions on the screen.

---

**5 Remove the CD-ROM as the shortcut icons of “PicturePackage Menu” and “PicturePackage destination Folder” are displayed after the installation.**

---

### **To start up the software**

- Double-click the “PicturePackage Menu” icon on the desktop.

### **For information on the use of the software**

Click [?] at the upper-right corner of each screen to show the on-line help.

Technical support for “PicturePackage”/“ImageMixer VCD2” is provided by the Pixela User Support Center. For more information, refer to the information included on the CD-ROM.

# Using your Macintosh computer

You can copy images to your computer and create a video CD using “ImageMixer VCD2” (supplied).

## Recommended environment

**OS (pre-installed):** Mac OS 9.1, 9.2, or Mac OS X (v10.0-v10.3)

**USB connector:** Provided as standard

## Recommended computer environment for using “ImageMixer VCD2”

**OS (pre-installed):** Mac OS X (v10.1.5 or later)

**CPU:** iMac, eMac, iBook, PowerBook, Power Mac G3/G4 series

**Memory:** 128 MB or more (256 MB or more is recommended.)

**Hard Disk:** Disk space required for installation - approximately 250 MB

**Display:** 1024 × 768 dots or more, 32,000 colors or more

- QuickTime 4 or later must be pre-installed. (QuickTime 5 or later is recommended.)

## Notes on connecting your camera to a computer

- Operations are not guaranteed for all the recommended computer environments mentioned above.
- If you connect two or more USB devices to a single computer at the same time, some devices, including your camera, may not operate depending on the types of USB devices you are using.
- Operations are not guaranteed when using a USB hub.
- Connecting your camera using a USB interface that is compatible with Hi-Speed USB (USB 2.0 compliant) allows advanced transfer (high speed transfer) as this camera is compatible with Hi-Speed USB (USB 2.0 compliant).
- There are two modes for a USB connection when connecting a computer, [Normal] (the default setting) and [PTP] modes. This section describes the [Normal] mode as an example. For details on [PTP], see page 54.
- When your computer resumes from the suspend or sleep mode, communication between your

camera and your computer may not recover at the same time.

## Copying and viewing images on a computer

### 1 Prepare the camera and a Macintosh computer.

Perform the same procedure as that described in “Stage 2: Preparing the camera and the computer” on page 59.

### 2 Connect the cable for multi-use terminal.

Perform the same procedure as that described in “Stage 3: Connecting the camera and your computer” on page 59.

- For DSC-ST80, also refer to the operating instructions “Cyber-shot Station”.

### 3 Copy image files to the Macintosh computer.

- ① Double-click the newly recognized icon → [DCIM] → the folder where the images you want to copy are stored.
  - ② Drag and drop the image files to the hard disk icon.  
The image files are copied to the hard disk.
- For details on the storage location of the images and file names, see page 63.

### 4 View images on the computer.

Double-click the hard disk icon → the desired image file in the folder containing the copied files to open that image file.

## To disconnect the cable for multi-use terminal/ remove the “Memory Stick”/ turn off the camera

Drag and drop the drive icon or the icon of the “Memory Stick” to the “Trash” icon, then remove the cable for the multi-use terminal, remove the “Memory Stick”, or turn off the camera.

- If you are using Mac OS X v10.0, perform the procedure above after you have turned your computer off.

## Creating a video CD using “ImageMixer VCD2”



- You can create an image file that is compatible with the video CD creation function. To save the data in the video CD format on a CD-R, you need Toast (not supplied) by Roxio.

## To install “ImageMixer VCD2”

- Shut down all other application software before you install “ImageMixer VCD2.”
- The display settings should be 1024 × 768 dots or higher and 32,000 colors or higher.

- ① Turn on your Macintosh computer, and insert the CD-ROM (supplied) into the CD-ROM drive.
- ② Double-click the CD-ROM icon.
- ③ Copy the [IMXINST.SIT] file in the [MAC] folder to the hard disk icon.
- ④ Double-click the [IMXINST.SIT] file in the copy-to folder.
- ⑤ Double-click the extracted [ImageMixer VCD2\_Install] file.

- ⑥ After the user information screen appears, enter the desired name and password. The installation of the software starts.

## To start up “ImageMixer VCD2”

Open [Image Mixer] in [Application], then double-click [ImageMixer VCD2].

## For information on the use of the software

Click [?] at the upper-right corner of each screen to show the on-line help.

Technical support for “ImageMixer VCD2” is provided by the Pixela User Support Center. For more information, refer to the information included on the CD-ROM.



# How to print still images

## Printing directly using a PictBridge compliant printer (page 70)

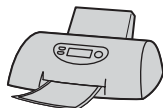

You can print images by connecting the camera directly to a PictBridge compliant printer.

## Printing directly using a “Memory Stick” compliant printer



You can print images with a “Memory Stick” compliant printer. For details, see the operating instructions supplied with the printer.

## Printing using a computer



You can copy images to a computer using the supplied “PicturePackage” software and print the images.

## Printing at a shop (page 73)

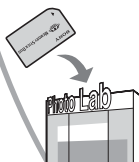

You can take a “Memory Stick” containing images shot with your camera to a photo printing service shop. You can make a  (Print order) mark on images that you want to print out in advance.

# Printing images directly using a PictBridge compliant printer

Even if you do not have a computer, you can print images shot using your camera by connecting the camera directly to a PictBridge compliant printer.

## PictBridge

- “PictBridge” is based on the CIPA standard. (CIPA: Camera & Imaging Products Association)

### In single-image mode

You can print a single image on a printing sheet.



### In index mode

You can print several images at a reduced size on a printing sheet. You can print a set of either the same images (①) or different images (②).

①

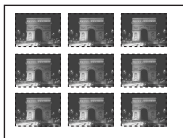

②



- An index print function may not be provided depending on the printer.
- The quantity of images that can be printed as an index image differ depending on the printer.
- You cannot print movies.
- If the  indicator flashes on the screen of the camera for about five seconds (error notification), check the connected printer.

## Stage 1: Preparing the camera

Prepare the camera to connect it to the printer with the cable for multi-use terminal.

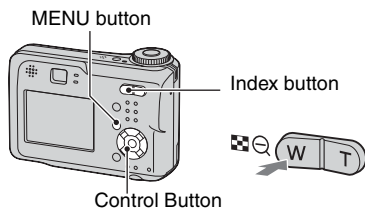

- It is recommended to use an AC Adaptor (not supplied) to prevent the power from turning off partway through printing.

**1** Press **MENU** to display the menu.

**2** Press **▶** on the control button to select **[Setup]**.

**3** Select **[Setup2]** with **▼**, then select **[USB Connect]** with **▲/▼/▶**.

**4** Select **[PictBridge]** with **▶/▲**, then press **●**.

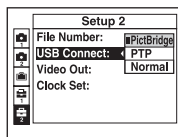

The USB mode is set.

- Connecting the camera to the printer when [PictBridge] is not selected turns off the LCD screen. Be sure to set [USB Connect] to [PictBridge].

## Stage 2: Connecting the camera to the printer

- For DSC-ST80, refer to the operating instructions "Cyber-shot Station".

### 1 Connect the multi connector on your camera and the USB jack on the printer with the cable for multi-use terminal (supplied with DSC-S90/S80/S60).

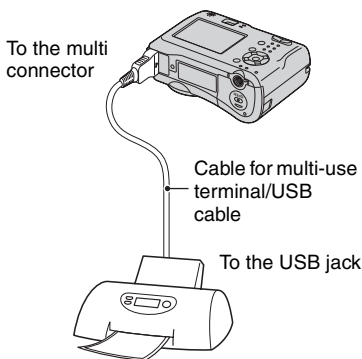

### 2 Turn on your camera and the printer.

After the connection is made, the indicator appears

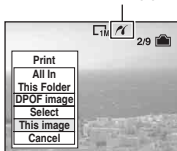

The camera is set to playback mode, then an image and the print menu appear on the screen.

## Stage 3: Printing

Regardless of what the mode dial is set to, the print menu appears when you complete Stage 2.

### 1 Select the desired printing method with $\blacktriangle/\blacktriangledown$ on the control button, then press $\bullet$ .

#### [All In This Folder]

Prints all the images in the folder.

#### [DPOF image]

Prints all the images with a (Print order) mark (page 73) regardless of the displayed image.

#### [Select]

Selects images and prints all the selected images.

#### ① Select the image you want to print with $\blacktriangle/\blacktriangleright$ , then press $\bullet$ .

The  $\checkmark$  mark appears on the selected image.

- To select other images, repeat this procedure.

#### ② Select [Print] with $\blacktriangledown$ , then press $\bullet$ .

#### [This image]

Prints a displayed image.

- If you select [This image] and set [Index] to [On] in step 2, you can print a set of the same images as an index image.

### 2 Select print settings with $\blacktriangle/\blacktriangledown/\blacktriangleleft/\blacktriangleright$ .

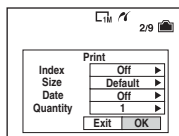

#### [Index]

Select [On] to print as an index image.

### [Size]

Select the size of the printing sheet.

### [Date]

Select [Day&Time] or [Date] to insert the date and time on images.

- When you choose [Date], the date will be inserted in the order you select (→ *step 2 in "Read This First"*). This function may not be provided depending on the printer.

### [Quantity]

When [Index] is set to [Off]:

Select the number of sheets of an image that you want to print. The image will be printed as a single image.

When [Index] is set to [On]:

Select the number of sets of images that you want to print as an index image.

If you selected [This image] in step 1, select the number of the same image you want to print side by side on a sheet as an index image.

- The designated number of images may not all fit onto a single sheet depending on the quantity of images.

---

## 3 Select [OK] with ▼/►, then press ●.

The image is printed.

- Do not disconnect the USB cable while the  (Do not disconnect the cable for multi-use terminal/the USB cable) indicator appears on the screen.

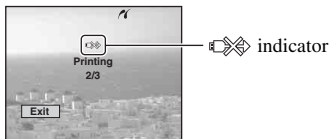



## To print other images

After step 3, select [Select] and the desired image with ▲/▼, then perform from step 1.

## To print images on the index screen

Perform "Stage 1: Preparing the camera" (page 70) and "Stage 2: Connecting the camera to the printer" (page 71), then proceed with the following.

When you connect the camera to a printer, the print menu appears. Select [Cancel] to turn off the print menu, then proceed as follows.

- ① Press  (Index).  
The index screen appears.
- ② Press MENU to display the menu.
- ③ Select  (Print) with ►, then press ●.
- ④ Select the desired printing method with ◀/►, then press ●.

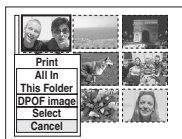

### [Select]

Selects images and prints all the selected images.

Select the image you want to print with ▲/▼/◀/►, then press ● to display the ✓ mark. (Repeat this procedure to select other images.) Then, press MENU.

### [DPOF image]

Prints all the images with a  (Print order) mark regardless of the displayed image.

### [All In This Folder]

Prints all the images in the folder.

- ⑤ Perform steps 2 and 3 of "Stage 3: Printing" (page 71).

# Printing at a shop

You can take a “Memory Stick” containing images shot with your camera to a photo printing service shop. As long as the shop supports photo printing services conforming to the DPOF, you can make a  (Print order) mark on images in advance so that you do not need to reselect them when you print them out at the shop.

- You cannot print images stored in the internal memory at a print shop directly from the camera. Copy the images to a “Memory Stick”, then take the “Memory Stick” to the print shop.

## What is DPOF?

DPOF (Digital Print Order Format) is a function allowing you to make a  (Print order) mark on images that you want to print out later.

- You can also print the images with the  (Print order) mark using a printer that conforms to the DPOF (Digital Print Order Format) standard or using a PictBridge compliant printer.
- You cannot mark movies.
- When you mark images shot in [Multi Burst] mode, all the images are printed on one sheet divided into 16 panels.

## When taking a “Memory Stick” to a shop

- Consult your photo printing service shop as to what types of “Memory Stick” they handle.
- If a “Memory Stick” is not handled by your photo printing service shop, copy the images you want to print out to other medium such as a CD-R and take it to the shop.
- When taking a “Memory Stick Duo”, be sure to take the Memory Stick Duo Adaptor with it.
- Before you take image data to a shop, always copy (back up) your data to a disk.
- You cannot set the number of prints.

## Marking in single-image mode

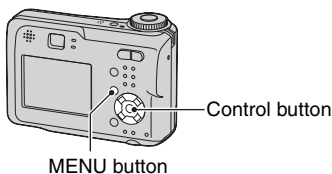



**1** Display the image you want to print.

**2** Press MENU to display the menu.

**3** Select DPOF with , then press .

A  (Print order) mark is marked on the image.



**4** To mark other images, display the desired image with , then press .

## To remove the mark in single-image mode

Press  in step 3 or 4.

## Marking in index mode

**1** Display the index screen. (→ *step 6 in "Read This First"*)

**2** Press MENU to display the menu.

**3** Select DPOF with ◀/▶, then press ●.

**4** Select [Select] with ▲/▼, then press ●.

- You cannot add a  mark in [All In This Folder].

**5** Select the image you want to mark with ▲/▼/◀/▶, then press ●.

A green  mark appears on the selected image.



Green  mark

**6** Repeat step 5 to mark other images.

**7** Press MENU.

**8** Select [OK] with ▶, then press ●.

The  mark turns white.

To cancel, select [Cancel] in step 4 or select [Exit] in step 8, then press ●.

### To remove the mark in index mode

Select the images from which you want to remove the mark in step 5, then press ●.

### To remove all the marks in the folder

Select [All In This Folder] in step 4, then press ●. Select [Off], then press ●.



## Viewing images on a TV screen

You can view images on a TV screen by connecting the camera to a TV.

Turn off both your camera and the TV before connecting the camera and the TV with the A/V cable.

- For DSC-ST80, refer to the operating instructions “Cyber-shot Station”.

- 1 Connect the cable for multi-use terminal (supplied with DSC-S90/S80/S60) to the multi connector of the camera and the audio/video input jacks of a TV.**

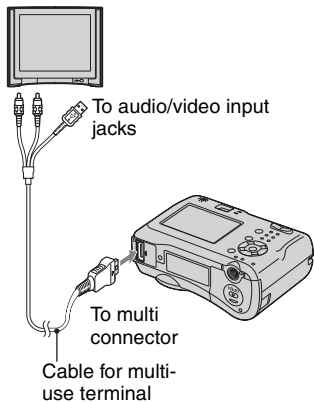

- Place the camera with the screen facing upwards.
- If your TV has stereo input jacks, connect the audio plug (black) of the cable for multi-use terminal to the left audio jack.



- 2 Turn on the TV and set the TV/video input switch to “video.”**

- For details, see the operating instructions supplied with the TV.

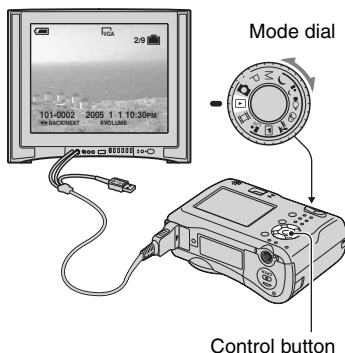
- 3 Set the mode dial to , and turn on the camera.**



Images shot with the camera appear on the TV screen.

Press   on the control button to select the desired image.

- When using your camera abroad, it may be necessary to switch the video signal output to match that of your TV system (page 54).

## **On TV color systems**

If you want to view images on a TV screen, you need a TV with a video input jack and the cable for multi-use terminal (supplied with DSC-S90/S80/S60) or the A/V connecting cable (supplied with DSC-ST80). The color system of the TV must match that of your digital still camera. Check the following lists:

### **NTSC system**

Bahama Islands, Bolivia, Canada, Central America, Chile, Colombia, Ecuador, Jamaica, Japan, Korea, Mexico, Peru, Surinam, Taiwan, the Philippines, the U.S.A., Venezuela, etc.

### **PAL system**

Australia, Austria, Belgium, China, Czech Republic, Denmark, Finland, Germany, Holland, Hong Kong, Hungary, Italy, Kuwait, Malaysia, New Zealand, Norway, Poland, Portugal, Singapore, Slovak Republic, Spain, Sweden, Switzerland, Thailand, United Kingdom, etc.

### **PAL-M system**

Brazil

### **PAL-N system**

Argentina, Paraguay, Uruguay

### **SECAM system**

Bulgaria, France, Guiana, Iran, Iraq, Monaco, Russia, Ukraine, etc.



# Troubleshooting

If you experience trouble with your camera, try the following solutions.

**❶ Check the items on pages 78 to 87.**

If a code such as “C/E:□□:□□” appears on the screen, see page 88.

**❷ Remove the batteries, and insert the batteries again after about one minute, and turn on the power.**

**❸ Initialize the settings (pages 53)**

**❹ Consult your Sony dealer or local authorized Sony service facility.**

Please understand that you give your consent that the contents of the internal memory may be checked when you send your camera to be repaired.

## Batteries and power

For DSC-ST80, also refer to the operating instructions “Cyber-shot Station”.

---

### The battery remaining indicator is incorrect, or sufficient battery remaining indicator is displayed but the power runs out too quickly.

- This phenomenon occurs when you use the camera in an extremely hot or cold location (page 93).
- When using alkaline batteries/Oxy Nickel Primary Battery, the displayed time remaining may not be correctly indicated.
- The batteries are discharged. Install charged batteries or replace with new ones (→ *step 1 in “Read This First”*).
- The poles of batteries or the terminals of battery cover are dirty so the batteries are not charged sufficiently. Clean them with a cotton swab, etc. (page 93).
- When using nickel-metal hydride batteries, the displayed time remaining differs from the current one due to the memory effect (page 93), etc. Fully discharge and then charge the batteries to correct the display.
- The batteries are dead (page 93). Replace them with new ones.

---

### The batteries run down too quickly.

- Charge nickel-metal hydride batteries sufficiently (→ *step 1 in “Read This First”*).
- You are using the camera in an extremely cold location (page 93).
- The batteries are dead (page 93). Replace them with new ones.

---

### Cannot turn on the camera.

- Install the batteries correctly (→ *step 1 in “Read This First”*).
- The batteries are discharged. Install charged batteries or replace with new ones (→ *step 1 in “Read This First”*).
- The batteries are dead (page 93). Replace them with new ones.

---

### The power turns off suddenly.

- If you do not operate the camera for about three minutes while the power is on, the camera turns off automatically to prevent wearing down the batteries. Turn on the camera again (→ *step 2 in “Read This First”*).
- The batteries are discharged. Install charged batteries or replace with new ones (→ *step 1 in “Read This First”*).



## Shooting still images/movies

### The screen does not turn on even when the power is turned on.

- Turn on the screen (page 21).

---

**Your camera cannot record images.**

- Check the free capacity of the internal memory or “Memory Stick” (page 18). If they are full, do one of the following:
  - Delete unnecessary images (→ *step 6 in “Read This First”*)
  - Change the “Memory Stick”.
- Set the write-protect switch on the “Memory Stick” to the recording position (page 91).
- You cannot record images while charging the flash.
- Set the mode dial to an other position than  and  when shooting still images.
- Set the mode dial to  when shooting movies.
- The image size is set to [640(Fine)] when recording movies. Do one of the following:
  - Set the image size to other than [640(Fine)].
  - Insert a “Memory Stick PRO” (page 91).

---

**The subject is not visible on the screen.**

- Set the mode dial to an other position than  (page 26).



---

**Recording takes a long time.**

- The NR slow shutter function is activated (page 27). This is not a malfunction.

---

**The image is out of focus.**

- The subject is too close. Record in the close-up (Macro) recording mode. Make sure to position the lens farther away from the subject than the shortest shooting distance, approximately 10 cm (4 inches) (W)/50 cm (19 3/4 inches) (T), when shooting (→ *step 5 in “Read This First”*).
-  (Twilight mode) or  (Landscape mode) is selected as the Scene mode when you shoot still images.
- The Focus preset function is selected. Select the auto focus mode (page 32).
- Refer to “If the subject is out of focus” on page 33.

---

**Zoom does not work.**

- You cannot change the zoom scale when shooting movies.

---

**Precision digital zoom does not function.**

- Set [Digital Zoom] to [Precision] (page 46).
- This function cannot be used while shooting movies.









---

**Smart zoom does not function.**

- Set [Digital Zoom] to [Smart] (page 46).
- This function cannot be used when:
  - The image size is set to [4M] or [3:2].
  - Shooting in [Multi Burst] mode.
  - Shooting movies.



---

### The flash does not work.

- The flash is set to  (No flash) (→ *step 5 in “Read This First”*).
- You cannot use the flash when:
  - [Mode] (REC Mode) is set to [Burst] or [Multi Burst] (page 35).
  -  (Twilight mode) or  (Candle mode) of the Scene mode, or  (movie) is selected.
- Set the flash to  (Forced flash) (→ *step 5 in “Read This First”*) to shoot still images when  (Landscape mode),  (Snow mode), or  (Beach mode) is selected as the Scene mode.

---

### The close-up (Macro) function does not work.

-  (Twilight mode),  (Landscape mode), or  (Candle mode) is selected for the Scene mode (page 27).

---

### The date and time are recorded incorrectly.

- Set the correct date and time (→ *step 2 in “Read This First”*).

---

### The F value and shutter speed flash when you press and hold the shutter button halfway down.

- The exposure is incorrect. Correct the exposure (page 31).

---

### The image is too dark.

- You are shooting a subject with a light source behind the subject. Select the metering mode (page 33) or adjust the exposure (page 31).
- The brightness of the screen is too low. Adjust the brightness of the LCD backlight (page 53).
- Turn on the screen (page 21).

---

### The image is too bright.

- You are shooting a spotlighted subject in a dark location such as on a stage. Adjust the exposure (page 31).
- The brightness of the screen is too bright. Adjust the brightness of the LCD backlight (page 53).

---

### The image colors are not correct.

- Picture Effect function is activated. Cancel the Picture Effect function (page 36).

---

### Vertical streaks appear when you are shooting a very bright subject.

- The smear phenomenon is occurring. This phenomenon is not a malfunction.

---

### Noise appears in the image when you view the screen in a dark place.

- The camera is attempting to increase the visibility of the screen by temporarily brightening the image under conditions of low illumination. There is no effect on the recorded image.

---

### The eyes of the subject come out red.

- Set [Red Eye Reduction] in the  (Setup) menu to [On] (page 47).
- Shoot the subject at a distance closer than the recommended shooting distance using the flash (→ *step 5 in "Read This First"*).
- Light the room and shoot the subject.

---

### The image seen through the finder does not indicate the actual recordable range.

- The parallax phenomenon is occurring when the subject is close. To confirm the recordable range, use the screen.

---

### Cannot shoot images in succession.

- The internal memory or the "Memory Stick" is full. Delete unnecessary images (→ *step 6 in "Read This First"*).
- The battery level is low. Install charged batteries or replace with new ones.

---

### Unknown pattern appears on the finder.

- This is due to the structure of the finder. This is not a malfunction.

## Viewing images

Refer to "Computers" (page 82) in conjunction with the following items.

---

### Your camera cannot play back images.

- Set the mode dial to  (page 26).
- The folder/file name has been changed on your computer.
- When an image file has been processed by a computer or when the image file was recorded using a model other than that of your camera, playback on your camera is not guaranteed.
- The camera is in USB mode. Delete the USB communication (page 62).

---

### The image appears rough right after playback starts.

- The image may appear rough right after playback starts due to image processing. This is not a malfunction.

---

### The image does not appear on the TV screen.

- Check [Video Out] to see if the video output signal of your camera is set to the color system of your TV (page 54).
- Check whether the connection is correct (page 75).
- The cable for multi-use terminal is connected. Disconnect it according to the correct procedure (page 62).

---

**The image does not appear on the screen.**

- If the cable for multi-use terminal is connected, disconnect it (page 75).

## Deleting/Editing images

**Your camera cannot delete an image.**

- Cancel the protection (page 40).
- Set the write-protect switch on the “Memory Stick” to the recording position (page 91).

---

**You have deleted an image by mistake.**

- Once you have deleted an image, you cannot restore it. We recommend that you set protection on an image (page 39), or set the write-protect switch on the “Memory Stick” to the LOCK position (page 91) to prevent accidental erasure.

---

**The resizing function does not work.**

- You cannot resize movies and Multi Burst images.

---

**You cannot display a DPOF (Print order) mark.**

- You cannot display DPOF (Print order) marks on movies.

---

**You cannot cut a movie.**

- The movie is not long enough to cut (shorter than about two seconds).
- Cancel the protection (page 40).
- Still images cannot be cut.

## Computers

**You do not know if the OS of your computer is compatible with the camera.**

- Check “Recommended computer environment” (page 57) for Windows, and “Recommended environment” (page 67) for Macintosh.

---

**You cannot install the USB driver.**

- In Windows 2000, log on as Administrator (authorized Administrators) (page 58).

---

**Your computer does not recognize your camera.**

- Turn on the camera (→ *step 2 in “Read This First”*).
- When the battery level is low, install the charged batteries, replace the batteries with new ones (→ *step 1 in “Read This First”*), or use the AC Adaptor (not supplied) (page 15).
- Use the cable for multi-use terminal (DSC-S90/S80/S60) or Cyber-shot Station (DSC-ST80) (page 59).

- Disconnect the cable for multi-use terminal (DSC-S90/S80/S60) or Cyber-shot Station (DSC-ST80) from both the computer and the camera, and connect it again firmly. Make sure that “USB Mode Normal” is displayed (page 59).
- Set [USB Connect] to [Normal] in the  (Setup) menu (page 54).
- Disconnect all equipment other than the camera, the keyboard and the mouse from the USB connectors of your computer.
- Connect the camera directly to your computer without passing through a USB hub or other device (page 59).
- The USB driver is not installed. Install the USB driver (page 58).
- Your computer does not properly recognize the device because you connected the camera and your computer with the cable for multi-use terminal (DSC-S90/S80/S60) or Cyber-shot Station (DSC-ST80) before you installed the “USB Driver” from the supplied CD-ROM. Delete the erroneously recognized device from your computer, then install the USB driver (see the next item).

---

### **The Removable disk icon does not appear on the computer screen when you connect your computer to the camera.**

- Follow the procedure below to install the USB driver again. The following procedure is for a Windows computer.
  - 1 Right-click [My Computer] to display the menu, then click [Properties].  
The “System Properties” screen appears.
  - 2 Click [Hardware] → [Device Manager].
    - For Windows 98/98SE/Me, click the [Device Manager] tab.  
The “Device Manager” appears.
  - 3 Right-click [ Sony DSC], then click [Uninstall] → [OK].  
The device is deleted.
  - 4 Install the USB driver (page 58).

---

### **You cannot copy images.**

- Connect the camera and your computer correctly using the supplied cable for multi-use terminal (DSC-S90/S80/S60) or Cyber-shot Station (DSC-ST80) (page 59).
- Follow the designated copy procedure for your OS (pages 60, 67).
- You may not be able to shoot using a “Memory Stick” formatted by a computer. Shoot using a “Memory Stick” formatted by your camera (page 51).

---

### **After making a USB connection, “PicturePackage” does not start automatically.**

- Start up the “PicturePackage Menu” and check [Settings].
- Make the USB connection after the computer is turned on (page 59).

---

### **The image cannot be played back on a computer.**

- If you are using “PicturePackage,” click on help at the upper-right corner of each screen.
- Consult the computer or software manufacturer.

---

### **The image and sound are interrupted by noise when you view a movie on a computer.**

- You are playing back the movie directly from the internal memory or the “Memory Stick”. Copy the movie to the hard disk of your computer, then play back the movie from the hard disk (page 58).

---

### **You cannot print an image.**

- Check the printer settings.

---

### **Images once copied to a computer cannot be viewed on the camera.**

- Copy them to a folder recognized by the camera, such as “101MSDCF” (page 63).
- Operate correctly (page 64).

## **“Memory Stick”**

---

### **Cannot insert a “Memory Stick”.**

- Insert it in the correct direction (→ *step 3 in “Read This First”*).

---

### **Cannot record on a “Memory Stick”.**

- Set the write-protect switch on the “Memory Stick” to the recording position (page 91).
- The “Memory Stick” is full. Delete unnecessary images (→ *step 6 in “Read This First”*).
- Insert a “Memory Stick PRO” (page 22) when recording movies with the image size set to [640(Fine)].

---

### **Cannot format a “Memory Stick”.**

- Set the write-protect switch on the “Memory Stick” to the recording position (page 91).

---

### **You have formatted a “Memory Stick” by mistake.**

- All the data on the “Memory Stick” is deleted by formatting. You cannot restore it. We recommend that you set the write-protect switch on the “Memory Stick” to the LOCK position to prevent accidental erasure (page 91).

## **Internal memory**

---

### **The camera or your computer cannot play back the data in the internal memory.**

- There is a “Memory Stick” inserted in the camera. Remove it (→ *step 3 in “Read This First”*).

---

### **Cannot record images using the internal memory.**

- There is a “Memory Stick” inserted in the camera. Remove it (→ *step 3 in “Read This First”*).

---

**The free capacity of the internal memory does not increase even when you copy the data stored in the internal memory to a “Memory Stick”.**

- The data is not deleted after copying. Execute the [Format] command (page 50) to format the internal memory after copying the data.

---

**Cannot copy the data stored in the internal memory to a “Memory Stick”.**

- The “Memory Stick” is full. Check the capacity.

---

**Cannot copy the data on the “Memory Stick” or the computer to the internal memory.**

- Data on a “Memory Stick” or a computer cannot be copied to the internal memory.

## **PictBridge compliant printer**

**A connection cannot be established.**

- The camera cannot be connected directly to a printer that is not compliant with the PictBridge standard. Consult the printer manufacturer as to whether the printer is compliant with PictBridge or not.
- Check that the printer is turned on and can be connected to the camera.
- Set [USB Connect] to [PictBridge] in the  (Setup) menu (page 54).
- Disconnect and connect the cable for multi-use terminal (DSC-S90/S80/S60) or Cyber-shot Station (DSC-ST80) again. If an error message is indicated on the printer, refer to the operating instructions supplied with the printer.

---

**The LCD screen turns off when you connect the camera to the printer.**

- Set [USB Connect] to [PictBridge], and then connect the camera again (page 70).

---

**Cannot print images.**

- Check that the camera and the printer are properly connected using the cable for multi-use terminal (DSC-S90/S80/S60) or Cyber-shot Station (DSC-ST80).
- Turn on the printer. For further information, refer to the operating instructions supplied with it.
- If you select [Exit] during printing, images may not print. Disconnect and connect the cable for multi-use terminal (DSC-S90/S80/S60) or Cyber-shot Station (DSC-ST80) again. If you still cannot print your images, disconnect the cable, turn the printer off and then on, then connect the cable again.
- Movies cannot be printed.
- Images shot using cameras other than this camera or images modified with a computer may not be printed.

---

**Printing is canceled.**

- You disconnected the cable for multi-use terminal (DSC-S90/S80/S60) or Cyber-shot Station (DSC-ST80) before the  (Do not disconnect the cable for multi-use terminal/the USB cable) mark disappears.

---

**Cannot insert the date or print images in the index mode.**

- The printer does not provide these functions. Consult the printer manufacturer as to whether the printer provides these functions or not.
- The date may not be inserted in the index mode depending on the printer. Consult the printer manufacturer.

---

**“---- -- --” is printed on the date-inserted part of the image.**

- Images that do not have the recording data cannot be printed with the date inserted. Set [Date] to [Off] and print the image again (page 72).

---

**Cannot select the print size.**

- Consult the printer manufacturer as to whether the printer can provide the desired size.

---

**Cannot print the image at the size selected.**

- Disconnect the cable for multi-use terminal (DSC-S90/S80/S60) or Cyber-shot Station (DSC-ST80) and reconnect it whenever you change the paper size after the printer has been connected to the camera.
- The print setting of the camera differs from that of the printer. Change the setting of either the camera (page 72) or the printer.

---

**Cannot operate the camera after canceling printing.**

- Wait for a while as the printer is carrying out the cancellation. It may take some time depending on the printer.

## Others

---

**Your camera does not work.**

- Use the type of batteries you can use with this camera (page 93).
- The battery level is low (The  indicator appears). Charge the batteries or replace with new ones (→ *step 1* in “*Read This First*”).

---

**The power is on, but the camera does not work.**

- The built-in microcomputer is not working properly. Remove the batteries, and then, after one minute, insert the batteries and turn on the camera.

---

**Cannot identify an indicator on the screen.**

- See page 17.

---

**The lens gets fogged.**

- Moisture condensation has occurred. Turn off the camera and leave it for about an hour before using it (page 95).

---

**The camera becomes warm when you use it for a long time.**

- This is not a malfunction.

---

**The lens does not move when you turn off the camera.**

- The batteries are discharged. Charge the batteries or install new batteries (→ *step 1 in “Read This First”*) or use the AC Adaptor (not supplied).

---

**The Clock Set screen appears when you turn on the camera.**

- Set the date and time again (→ *step 2 in “Read This First”*).

# Warning indicators and messages

## Self-diagnosis display

If a code starting with a letter of the alphabet appears, your camera has a self-diagnosis display. The last two digits (indicated by □□) will differ depending on the state of the camera.

If you are unable to solve the problem even after trying the following corrective actions a few times, contact your Sony dealer or local authorized Sony service facility.

---

### C:32: □□

- There is trouble with your camera's hardware. Turn the power off and on again.

---

### C:13: □□

- The camera cannot read or write data. Turn off and on the power or re-insert the "Memory Stick" several times.
- Format error has occurred in the internal memory or an unformatted "Memory Stick" is inserted. Format the media (pages 50, 51).
- The inserted "Memory Stick" cannot be used with your camera, or the data is damaged. Insert a new "Memory Stick" (page 91).

---

### E:61: □□

### E:91: □□

### E:92: □□

- A camera malfunction has occurred. Initialize the camera (page 53), then turn the power on again.

## Messages

If the following messages appear, follow the instructions.

---

### Turn the power off and on again

- A problem with the lens has caused an error.



- The battery level is low. Charge the batteries (→ *step 1* in "Read This First"). Depending on the conditions of use or the type of battery, the indicator may flash even though there are still 5 to 10 minutes of remaining battery time left.

---

### System error

- Turn the power off and then on again (→ *step 2* "Read This First").

---

### Internal memory error

- Turn the power off and then on again (→ *step 2* "Read This First").

---

### Memory Stick error

- Insert the "Memory Stick" correctly.
- The inserted "Memory Stick" cannot be used in your camera (page 91).
- The "Memory Stick" is damaged.
- The terminal section of the "Memory Stick" is dirty.

---

### Memory Stick type error

- The inserted "Memory Stick" cannot be used in your camera (page 91).

---

### Format error

- Format the media again (pages 50, 51).

---

### Memory Stick locked

- Set the write-protect switch on the “Memory Stick” to the recording position (page 91).

---

### No memory space in internal memory

#### No memory space in Memory Stick

- Delete unnecessary images or files (→ step 6 “*Read This First*”).

---

### Read only memory

- Your camera cannot record or delete images on this “Memory Stick”.

---

### No file

- No images have been recorded in the internal memory.

---

### No file in this folder

- No images have been recorded in this folder.
- You did not operate correctly when copying images from your computer (page 64).

---

### Folder error

- A folder with the same first three digit number already exists on the “Memory Stick”. (For example: 123MSDCF and 123ABCDE) Select other folders, or create a new folder (page 51).

---

### Cannot create more folders

- The folder with a name beginning with “999” exists on the “Memory Stick”. You cannot create any folders if this is the case.

---

### Cannot record

- The camera cannot record images in the selected folder. Select a different folder (page 52).

---

### File error

- An error occurred while playing back the image.

---

### File protect

- Release the protection (page 40).

---

### Image size over

- You are playing back an image of a size that cannot be played back on your camera.

---

### Cannot divide

- The movie is not long enough to be divided (shorter than about two seconds).
- The file is not a movie.

---

### Invalid operation

- You are playing back a file that was created on equipment other than this camera.

---

### (Vibration warning indicator)

- Camera shake may occur due to insufficient light. Use the flash, mount the camera on a tripod, or otherwise secure the camera in place.

---

### 640(Fine) is not available

- 640(Fine) size movies can be recorded only using a “Memory Stick PRO”. Insert a “Memory Stick PRO” or set the image size to a size other than [640(Fine)].

---

### Enable printer to connect

- [USB Connect] is set to [PictBridge], however the camera is connected to a non-PictBridge compliant device. Check the device.
- The connection is not established. Disconnect and connect the cable for multi-use terminal (DSC-S90/S80/S60) or Cyber-shot Station (DSC-ST80) again. If an error message is indicated on the printer, refer to the operating instructions supplied with the printer.

---

### Connect to PictBridge device

- You tried to print images before the printer connection was established. Connect to a PictBridge compliant printer.

---

### No printable image

- You tried to execute [DPOF image] without placing a DPOF (Print order) mark on the image(s).
- You tried to execute [All In This Folder] while a folder that holds only movies was selected. You cannot print movies.

---

### Printer busy

#### Paper error

#### No Paper

#### Ink error

#### Low Ink

#### No Ink

- Check the printer.

---

### Printer error

- Check the printer.
- Check if the image you want to print is corrupted.



- The data transmission to the printer may not be completed yet. Do not disconnect the cable for multi-use terminal (DSC-S90/S80/S60) or the USB cable (DSC-ST80).

---

### Processing

- The printer is canceling the current print job. You cannot print until it is finished. This may take time, depending on the printer.



# On the “Memory Stick”

A “Memory Stick” is a compact, portable IC recording medium. The types of “Memory Stick” that can be used with this camera are listed in the table below. However, proper operation cannot be guaranteed for all “Memory Stick” functions.

“Memory Stick” type	Recording/Playback
Memory Stick	○
Memory Stick (MagicGate/High-speed data transfer compatible)	○ <sup>*2</sup> *3
Memory Stick Duo <sup>*1</sup>	○
Memory Stick Duo (MagicGate/High-speed data transfer compatible) <sup>*1</sup>	○ <sup>*2</sup> *3
MagicGate Memory Stick	○ <sup>*2</sup>
MagicGate Memory Stick Duo <sup>*1</sup>	○ <sup>*2</sup>
Memory Stick PRO	○ <sup>*2</sup> *3*4
Memory Stick PRO Duo <sup>*1</sup>	○ <sup>*2</sup> *3*4

<sup>\*1</sup>When using a “Memory Stick Duo” with this camera, be sure to insert it into a Memory Stick Duo Adaptor.

<sup>\*2</sup>“MagicGate Memory Stick” and “Memory Stick PRO” are equipped with MagicGate functions. MagicGate is copyright protection technology that uses encryption technology. Data recording/playback that requires MagicGate functions cannot be performed with this camera.

<sup>\*3</sup>Supports high-speed data transfer using a parallel interface.

<sup>\*4</sup>640(Fine) size movies can be recorded.

- A “Memory Stick” formatted with a computer is not guaranteed to operate with this camera.
- Data read/write speeds differ depending on the combination of the “Memory Stick” and the equipment used.

## Notes on using a “Memory Stick” (not supplied)

- You cannot record, edit or delete images if you slide the write-protect switch to LOCK.

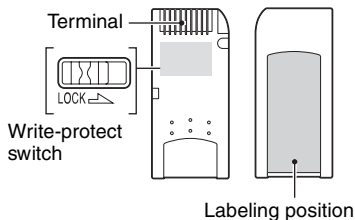

The position and/or the shape of the write-protect switch may differ depending on the “Memory Stick” you use.

- Do not remove the “Memory Stick” while reading or writing data.
- Data may be corrupted in the following cases:
  - When the “Memory Stick” is removed or the camera is turned off during a read or write operation
  - When the “Memory Stick” is used in locations subject to static electricity or electrical noise
- We recommend backing up important data.
- Do not attach any other material than the supplied label on the labeling position.
- When you attach the supplied label, be sure to attach it to the labeling position. Be careful that the label does not stick out.
- When you carry or store the “Memory Stick”, put it in the case supplied with it.
- Do not touch the terminal of the “Memory Stick” with your hand or a metal object.
- Do not strike, bend or drop the “Memory Stick”.
- Do not disassemble or modify the “Memory Stick”.
- Do not expose the “Memory Stick” to water.
- Do not use or store the “Memory Stick” under the following conditions:
  - High temperature locations such as the hot interior of a car parked in direct sunlight
  - Locations exposed to direct sunlight
  - Humid locations or locations with corrosive substances present

### **Notes on using a “Memory Stick Duo” (not supplied)**

- To use a “Memory Stick Duo” with the camera, be sure to insert the “Memory Stick Duo” into a Memory Stick Duo Adaptor. If you insert a “Memory Stick Duo” into a “Memory Stick” compliant device without a Memory Stick Duo Adaptor, you might not be able to remove it from the device.
- When inserting a “Memory Stick Duo” into a Memory Stick Duo Adaptor, make sure the “Memory Stick Duo” is inserted facing in the correct direction.
- When using a “Memory Stick Duo” inserted into a Memory Stick Duo Adaptor with the camera, make sure that the “Memory Stick Duo” is inserted facing the correct direction. Note that improper use may damage the equipment.
- Do not insert a Memory Stick Duo Adaptor into a “Memory Stick” compliant device without a “Memory Stick Duo” attached. Doing so may result in malfunction of the unit.
- To format a “Memory Stick Duo”, insert the “Memory Stick Duo” into the Memory Stick Duo Adaptor.
- When the “Memory Stick Duo” is equipped with the write-protect switch, release its lock.

### **Note on using a “Memory Stick PRO” (not supplied)**

- “Memory Stick PRO” media with a capacity of up to 2 GB have been confirmed to operate properly with this camera.

# On the battery charger and the batteries

## On the battery charger (supplied with DSC-S90/S80)

- Do not charge any other batteries except Sony Nickel-Metal Hydride batteries in the battery charger supplied with your camera. If you try to charge any other type of battery (e.g., manganese batteries, alkaline dry cells, primary lithium batteries, or Ni-Cd batteries) than the batteries specified, those batteries may leak, overheat, or explode, causing the danger of burns or other injuries.
- Remove the charged batteries from the battery charger. If you keep charging them, there is a danger of leaks, excessive heat, explosions, or electric shock.
- When charging a high capacity battery other than the supplied battery using the supplied battery charger, the full capacity of the battery may not be available.
- When the CHARGE lamp flashes, this may indicate a battery error or that batteries other than the specified type have been inserted. Check that the batteries are the specified type. If the batteries are the specified type, remove all the batteries, replace them with new ones or another ones and check if the battery charger operates correctly. If the battery charger operates correctly, a battery error may have occurred.
- If the battery charger is dirty, charging may not be performed successfully. Clean the battery charger with dry cloth, etc.

## Batteries you can use with your camera

HR 15/51:HR6 (size AA) Nickel-Metal Hydride batteries (2)

- NH-AA-DA (2) (supplied with DSC-S90/S80)
- NH-AA-2DB twin pack, etc.

Battery pack NP-NH25 (supplied with DSC-ST80)

R6 (size AA) alkaline batteries (2) (supplied with DSC-S60)

ZR6 (size AA) Oxy Nickel Primary Battery (2)

## Batteries you cannot use with your camera

Manganese batteries

Lithium batteries

Ni-Cd batteries

If you use the above batteries, we cannot guarantee full performance of the camera by property of the batteries, such as brownout of the batteries.

## On Nickel-Metal Hydride batteries

- Do not peel off the external seals or damage the batteries. Never use batteries from which the seals have been partially or completely removed, or batteries that have been split in any way. These may cause leakage, explosion, or heat-up of the battery, and personal scald or injury may be caused. These may cause a malfunction of the battery charger.
- Always carry the Nickel-Metal Hydride batteries in the battery case (supplied with DSC-S90/S80). Otherwise, metallic objects may short the + and - ends, resulting in the risk of heating or fire.
- If the poles of the Nickel-Metal Hydride batteries are dirty, the batteries may not charge properly. Wipe them with a dry cloth, etc.
- At the time of purchase, or when the Nickel-Metal Hydride batteries have not been used for a long time, they may not full charge. This is typical of this type of battery, and is not a malfunction. If this happens, repeatedly using up the batteries fully, and then recharging them should correct the problem.
- If you recharge Nickel-Metal Hydride batteries before fully using up the existing charge, the low battery warning may be displayed sooner than expected. This is called the "memory effect."\* If this problem occurs, charging the batteries only after using up the existing charge will correct it.
  - \* The "memory effect" - the situation in which the capacity of the battery is temporarily lowered.
- To use up the batteries completely, put the camera in the slide show mode (page 40) and leave it that way until the batteries are used up.
- Do not mix new and used batteries.
- Do not expose the battery to water. The battery is not water-resistant.

## Effective use of Nickel-Metal Hydride batteries

- Batteries are discharged even when they are not used. We recommend you charge the batteries just before using them.
- Battery performance decreases in low-temperature surroundings, and the battery life is shortened under such circumstances. To use the battery longer, we recommend you keep the battery in its case in a pocket close to your body to warm it, and insert it in your camera just before you start shooting.
- If the poles of the batteries and the terminals on the battery cover of the camera are dirty, the battery life may be extremely shortened. Occasionally wipe them with a dry cloth, etc. to keep them clean.
- If you shoot a lot using the flash and the zoom, the battery power will be used up faster.
- We recommend having spare batteries handy for two or three times the expected shooting time, and try test shooting before actually using the camera.

## Battery life of Nickel-Metal Hydride batteries

- The battery life is limited. The battery capacity decreases little by little as you use it more and more, and as time passes. When the battery operating time seems to have been considerably shortened, a probable cause is that the batteries have reached the end of their life.
- The battery life varies depending on storage, operating conditions, and environment, and is different for each battery.

## On alkaline batteries/Oxy Nickel Primary Battery

- Alkaline batteries/Oxy Nickel Primary Battery have a shorter life compared to the Nickel-Metal Hydride batteries. For this reason, the power may turn off even though the battery remaining indicator shows sufficient battery life remaining.
- Battery performance differs greatly depending on the manufacturer and the type of battery, and in some cases the battery life may be extremely short. This is especially true at low temperatures, and you may not be able to shoot at temperatures below 5°C (41°F).
- Do not mix new and old batteries.

- The battery remaining indicator may not display the correct information when using alkaline batteries/Oxy Nickel Primary Battery.
- Due to characteristics of alkaline batteries/Oxy Nickel Primary Battery, there is a large difference between the available shooting time and the available playback time. For this reason, the camera may turn off with the lens portion extended when you switch the mode dial. In this case, replace the batteries with new ones or fully charged Nickel-Metal Hydride batteries.

## Precautions on the battery pack NP-NH25

- Refer to the operating instructions “Cyber-shot Station”.

# Precautions

## ■ Do not leave the camera in the following places

- In an extremely hot place  
In places such as in a car parked in the sun, the camera body may become deformed and this may cause a malfunction.

- Under direct sunlight or near a heater  
The camera body may become discolored or deformed, and this may cause a malfunction.

- In a location subject to rocking vibration

- Near strong magnetic place

- In sandy or dusty places

Be careful not to let sand or dust get into the camera. This may cause the camera to malfunction, and in some cases this malfunction cannot be repaired.

## ■ On cleaning

### Cleaning the LCD screen

Wipe the screen surface with an LCD cleaning kit (not supplied) to remove fingerprints, dust, etc.

### Cleaning the lens

Wipe the lens with a soft cloth to remove fingerprints, dust, etc.

### Cleaning the camera surface

Clean the camera surface with a soft cloth slightly moistened with water, then wipe the surface with a dry cloth. Do not use the following as they may damage the finish or the casing.

- Chemical products such as thinner, benzene, alcohol, disposable cloths, insect repellent, or insecticide, etc.
- Do not touch the camera with the above on your hand.
- Do not leave the camera in contact with rubber or vinyl for a long time.

## ■ On operating temperatures

Your camera is designed for use under the temperatures between 0°C and 40°C (32°F and 104°F). (In case of alkaline batteries/Oxy Nickel Primary Battery, the temperatures are between 5°C and 40°C (41°F and 104°F).) Shooting in extremely cold or hot places that exceed this range is not recommended.

## ■ On moisture condensation

If the camera is brought directly from a cold to a warm location, moisture may condense inside or outside the camera. This moisture condensation may cause a malfunction of the camera.

### Moisture condensation occurs easily when:

- The camera is brought from a cold location such as a ski slope into a warmly heated room
- The camera is taken from an air-conditioned room or car interior to the hot outdoors, etc.

### How to prevent moisture condensation

When bringing the camera from a cold place to a warm place, seal the camera in a plastic bag and allow it to adapt to conditions at the new location over about an hour.

### If moisture condensation occurs

Turn off the camera and wait about an hour for the moisture to evaporate. Note that if you attempt to shoot with moisture remaining inside the lens, you will be unable to record clear images.

## ■ On the internal rechargeable battery

This camera has an internal rechargeable battery for maintaining the date and time and other settings regardless of whether the power is on or off.

This rechargeable battery is continually charged as long as you are using the camera. However, if you use the camera for only short periods, it discharges gradually, and if you do not use the camera at all for about one month it becomes completely discharged. In this case, be sure to charge this rechargeable battery before using the camera.

However, even if this rechargeable battery is not charged, you can still use the camera as long as you do not record the date and time.

### Charging method

Insert batteries with enough capacity in the camera, or connect the camera to a wall outlet (wall socket) using the AC Adaptor (not supplied), and leave the camera for 24 hours or more with the power off.

# Specifications

## Camera

### [System]

Image device	6.85 mm (1/2.7 type) color CCD, Primary color filter
Total pixel number of camera	Approx. 4 231 000 pixels
Effective pixel number of camera	Approx. 4 065 000 pixels
Lens	Carl Zeiss Vario-Tessar 3× zoom lens f = 6.0 - 18.0 mm (39 - 117 mm when converted to a 35 mm still camera) F2.8 - 5.2
Exposure control	Automatic exposure, Manual exposure, Scene Selection (7 modes)
White balance	Automatic, Daylight, Cloudy, Fluorescent, Incandescent
File format (DCF compliant)	Still images: Exif Ver. 2.2 JPEG compliant, DPOF compatible Movies: MPEG1 compliant (Monaural)
Recording media	Internal memory 32 MB “Memory Stick”
Flash	Recommended distance (ISO set to Auto): 0.2 m to 4.5 m (7 7/8 inches to 178 1/2 inches) (W)/0.5 m to 2.5 m (19 3/4 inches to 98 1/2 inches) (T)

### [Input and Output connectors]

Multi connector	
USB communication	Hi-Speed USB (USB 2.0 compliant)

### [LCD screen]

LCD panel	DSC-S90: 6.2 cm (2.5 type) TFT drive DSC-S80/ST80/S60: 5.1 cm (2.0 type) TFT drive
Total number of dots	115 200 (480×240) dots

## [Power, general]

Power	HR15/51:HR6 (Size AA) Nickel-Metal Hydride batteries (2) (supplied with DSC-S90/S80), 2.4 V R6 (size AA) Alkaline batteries (2) (supplied with DSC-S60), 3 V Battery pack NP-NH25 (1) (supplied with DSC-ST80) ZR6 (size AA) Oxy Nickel Primary Battery (2) (not supplied), 3 V AC-LS5K AC Adaptor (not supplied), 4.2 V
Power consumption (during shooting with the LCD screen on)	DSC-S90: 1.1 W DSC-S80/ST80/S60: 1.0 W
Operating temperature	0°C to +40°C (+32°F to +104°F)
Storage temperature	-20°C to +60°C (-4°F to +140°F)
Dimensions	96.6×64.4×40.1 mm (3 7/8×2 5/8×1 5/8 inches) (W/H/D, excluding maximum protrusions)
Mass	DSC-S90: Approx. 253 g (8 oz) (including two batteries and wrist strap) DSC-S80/ST80/S60: Approx. 249 g (8 oz) (including two batteries and wrist strap)
Microphone	Electret condenser microphone
Speaker	Dynamic speaker
Exif Print	Compatible
PRINT Image Matching III	Compatible
PictBridge	Compatible

## **BC-CS2A/CS2B Ni-MH battery charger (supplied with DSC-S90/S80)**

### Power requirements

AC 100 to 240 V, 50/60 Hz,  
3 W

Output voltage AA: DC 1.4V 400 mA × 2  
AAA: DC 1.4 V 160 mA × 2

### Operating temperature

0°C to +40°C (+32°F to  
+104°F)

### Storage temperature

-20°C to +60°C (-4°F to  
+140°F)

Dimensions Approx. 71×30×91 mm  
(2 7/8×1 3/16×3 5/8 inches)  
(W/H/D)

Mass Approx. 90 g (3 oz)

For DSC-ST80, also refer to the operating instructions "Cyber-shot Station".

Design and specifications are subject to change without notice.

## A

- A/V cable.....75
- Accessories supplied
  - *in "Read This First"*
- AE/AF indicator
  - *step 5 in "Read This First"*
- AF Illuminator.....48
- AF lock.....33
- AF Mode.....46
- AF range finder frame.....32
- AF range finder frame indicator
  - .....32
- Aperture.....11, 27
- Auto adjustment mode
  - *step 5 in "Read This First"*
- Auto Focus.....10
- Auto power-off function
  - *step 2 in "Read This First"*
- Auto Review.....48

## B

- Back up.....23
- Battery
  - Charging
    - *step 1 in "Read This First"*
  - Install/Remove
    - *step 1 in "Read This First"*
  - Remaining indicator
    - *step 1 in "Read This First"*
- Beach mode
  - *step 5 in "Read This First"*
- Beep.....53
- Blur.....10
- Burst.....35

## C

- Cable for multi-use terminal
    - .....59, 75
  - Camera 1.....46
  - Camera 2.....49
  - Candle mode
    - *step 5 in "Read This First"*
  - CD-ROM.....58
  - Center AF.....32
  - Change REC. Folder.....52
  - Charging battery pack
    - *step 1 in "Read This First"*
  - Cleaning.....95
  - Clock Set.....55
  - Cloudy.....34
  - Color.....12
  - Compression ratio.....14
  - Computer
    - Copying still images.....58
    - Macintosh.....67
    - Recommended environment.....57, 67
    - Software.....65
    - Viewing image stored on a computer with your camera.....64
    - Windows.....56
  - Connecting
    - Computer.....59
    - Printer.....71
    - TV.....75
  - Contrast.....37
  - Copy.....52
  - Copying still images to your computer.....58
  - Create REC. Folder.....51
- ## D
- Date.....47
  - Date/Time.....47

- Day&Time.....47
- Daylight.....34
- Delete
  - *step 6 in "Read This First"*
- Digital Zoom.....46
- DirectX.....57
- Divide.....42
- DPOF.....73

## E

- Effective pixels.....96
- Electronic transformer
  - *step 1 in "Read This First"*
- Enlarged Icon.....49
- Enlarging an image
  - *step 6 in "Read This First"*
- EV.....31
- Exposure.....11, 27
- Extension.....64

## F

- F value.....11, 27
- File name.....63
- File Number.....54
- File storage destination.....63
- Fine.....34
- Flash Level.....36
- Flash mode
  - *step 5 in "Read This First"*
- Fluorescent.....34
- Focus.....10, 32
- Focus preset.....32
- Folder.....38
  - Changing.....52
  - Creating.....51
- Forced flash
  - *step 5 in "Read This First"*

Format.....50, 51

## H

Histogram .....21, 31

Holding the camera  
→ *step 5 in "Read This First"*

## I

Identifying parts.....15

Image file storage destinations  
and file names.....63

Image quality .....13, 34

Image size .....13  
→ *step 4 in "Read This First"*

ImageMixer VCD2 .....68

Incandescent .....34

Index mode .....70

Index screen  
→ *step 6 in "Read This First"*

Indicator ..... see "Screen"

Initialize .....53

Install .....58, 65, 68

Internal memory.....23  
Format .....50

Internal Memory Tool.....50

Internal rechargeable  
battery.....95

Interval .....36

ISO.....11, 12, 34

## J

JPG.....63

## L

Landscape mode  
→ *step 5 in "Read This First"*

Language.....53  
→ *step 2 in "Read This First"*

LCD Backlight .....53

LCD screen .....see "Screen"

## M

M AF .....46

Macintosh computer.....67  
Recommended  
environment .....67

Macro  
→ *step 5 in "Read This First"*

Mains lead  
→ *step 1 in "Read This First"*

Manual exposure .....27

"Memory Stick" .....91

Insert/Remove  
→ *step 3 in "Read This First"*

Format .....51

Number of images/  
recording time .....22

Write-protect switch .....91

Memory Stick Tool .....51

Menu .....29

Items.....30

Shooting .....31

Viewing .....38

Metering Mode.....33

Mode .....35

Moisture condensation .....95

Monitor.....46

Monochrome .....36

MPG .....63

Multi AF.....32

Multi Burst .....35

Multi-pattern metering .....33

Multipoint AF .....32

## N

NR slow shutter.....28

NTSC .....54

Number of images/Recording  
time.....22

## O

Optical zoom .....46

OS .....57, 67

Overexposure .....11

## P

P.Effect.....36

PAL .....54

Parallax .....81

PC ..... see "Computer"

PFX.....36

PictBridge.....70

Picture effect.....36

PicturePackage.....65

Pixel .....13

Playback ..... see "Viewing"

Playback/Edit.....26

Power cord  
→ *step 1 in "Read This First"*

Precautions .....95

Precision digital zoom .....46

Pressing halfway down.....10  
→ *step 5 in "Read This First"*

Print .....69

Index mode.....70

Single-image mode.....70

Print order mark.....73

Printing at a shop.....73

Printing directly .....70

Program auto shooting.....26

Protect.....39

PTP .....54

## Q

Quick Review  
→ *step 5 in "Read This First"*

## R

REC Mode.....	35
Red Eye Reduction.....	47
Resize .....	41
Rewind/Fast forward → step 6 in “Read This First”	
Rotate.....	42

## S

S AF.....	46
Saturation.....	37
Scene → step 5 in “Read This First”	
Screen Changing the display.....	21
Indicator .....	17
LCD Backlight .....	53
Self-diagnosis display.....	88
Self-timer → step 5 in “Read This First”	
Sepia.....	36
Setting the clock → step 2 in “Read This First”	
Setup.....	37, 44, 45
Camera 1 .....	46
Camera 2 .....	49
Internal Memory Tool ...	50
Memory Stick Tool .....	51
Setup 1.....	53
Setup 2.....	54
Setup 1 .....	53
Setup 2 .....	54
Sharpness.....	37
Shooting Movie → step 5 in “Read This First”	

Still image  
→ step 5 in “Read This  
First”

Shooting menu .....	31
Shooting movies.....	26
Shutter speed.....	11, 27
Single .....	46
Single-image mode .....	70
Slide .....	40
Slow synchro → step 5 in “Read This First”	
Smart zoom.....	46
Snow mode → step 5 in “Read This First”	
Soft snap mode → step 5 in “Read This First”	
Software .....	65
Specifications.....	96
Spot metering .....	33
Spot metering cross hairs....	33
Standard .....	34

## T

Trimming .....	44
Tripod receptacle .....	15
Troubleshooting.....	77
TV .....	75
Twilight mode → step 5 in “Read This First”	
Twilight portrait mode → step 5 in “Read This First”	

## U

Underexposure .....	11
USB Connect .....	54
USB Driver .....	58
Using your camera abroad → step 1 in “Read This First”	

## V

VGA → step 4 in “Read This First”	
Video CD.....	65, 68
Video Out .....	54
Viewing Movie → step 6 in “Read This First”	
Still image → step 6 in “Read This First”	
Viewing menu.....	38
Volume → step 6 in “Read This First”	

## W

Warning indicators and messages .....	88
WB .....	34
White balance .....	34
Windows computer.....	56
Recommended environment.....	57
Wrist strap → in “Read This First”	
Write-protect switch.....	91

## Z

Zoom → step 5 in “Read This First”	
--	--

## Trademarks

- **Cyber-shot** and Cyber-shot Station are trademarks of Sony Corporation.
- “Memory Stick” , “Memory Stick PRO”, **MEMORY STICK PRO**, “Memory Stick Duo”, **MEMORY STICK DUO**, “Memory Stick PRO Duo”, **MEMORY STICK PRO DUO**, “MagicGate”, and **MAGICGATE** are trademarks of Sony Corporation.
- Picture Package is a trademark of Sony Corporation.
- Microsoft, Windows, Windows Media, and DirectX are either registered trademarks or trademarks of Microsoft Corporation in the United States and/or other countries.
- Macintosh, Mac OS, QuickTime, iMac, iBook, PowerBook, Power Mac, and eMac are trademarks or registered trademarks of Apple Computer, Inc.
- Macromedia and Flash are trademarks or registered trademarks of Macromedia, Inc. in the United States and/or other countries.
- Intel, MMX, and Pentium are trademarks or registered trademarks of Intel Corporation.
- In addition, system and product names used in this manual are, in general, trademarks or registered trademarks of their respective developers or manufacturers. However, the <sup>TM</sup> or ® marks are not used in all cases in this manual.



