

SAMSUNG

VEGA 170
EVOCA 170SE



ENGLISH

NOTE

- This camera will not function without a battery.
- Use one 3V lithium battery(CR-123A or DL-123A).
- The lens cap automatically opens when the Power button is turned on.
- Do not open the lens cap with your fingers.

The shutter does not operate in the following circumstances:

- When the camera has no battery or when the battery is almost drained.
- When the Power is turned off.(When the lens cap is closed.)
- When the zoom button is operating or when the film is winding or rewinding.
(Rewinding will stop when the shutter button is pressed during rewinding.)
- When the film remains in the camera after rewinding.
- When the flash is being charged.

※ This camera is controlled electronically by a built-in microcomputer. Although unlikely, it may fail to operate under certain circumstances in which there is a strong electromagnetic field (near a TV, microwave etc.). If this occurs, please remove the lithium battery and replace after 2~3 minutes.

CONTENTS

Thank you for purchasing the SAMSUNG camera. Please read this manual before using your camera.

TABLE OF CONTENTS

PREPARATION

. Part names	4
. LCD panel	7
. Viewfinder and Indicators	8
. Loading the battery	9
. Checking the battery	10
. Loading the film	11
. Attaching the strap	12
. Using the camera	13
. Holding the camera	14
. Taking pictures	15
. Adjusting the diopter	16
. Buzzer operation	17

TAKING PHOTOS

. Rewinding the film	18
. Date and caption (Q.D. model only)	19
. Using the flash mode	21
. Using the shooting mode	22
. Using the self mode	23
. Auto red-eye reduction	24
. Auto flash	25
. Flash off	26

. Fill-in flash	26
. Fill-in flash and red-eye reduction	27
. Bulb shooting(B Shutter)	28
. Flash off & bulb shooting(B Shutter)	29
. Snap shooting	30
. Portrait zoom	31
. Continuous shooting	32
. Spot shooting	33
. Landscape shooting	34
. Using the focus lock	35
. Self-timer	36
. Double self-timer	37
. 2 second delayed shutter release	38
. Remote control shooting(Optional)	39
. Replacing the battery of the remote control(Optional)	40
. Macro photography	41
. Panorama photography	42

IMPORTANT NOTES

. Care and storage	43
. Trouble shooting	44

SPECIFICATIONS

. Checking the camera	47
-----------------------------	----

PART NAMES

· Front / Top

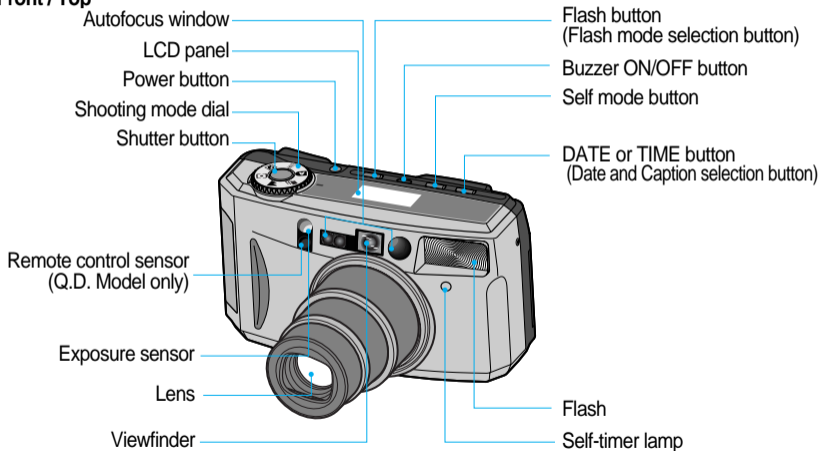

· Rear / Bottom

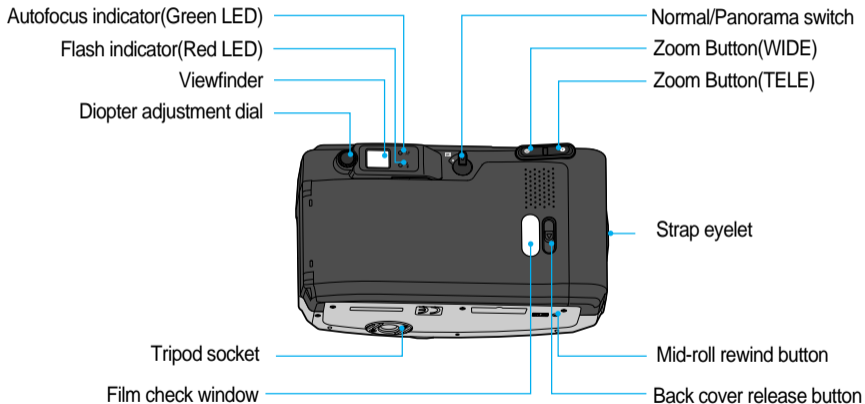

· Interior

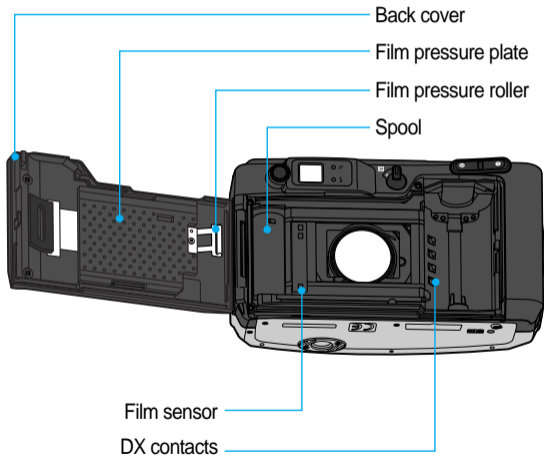

LCD PANEL

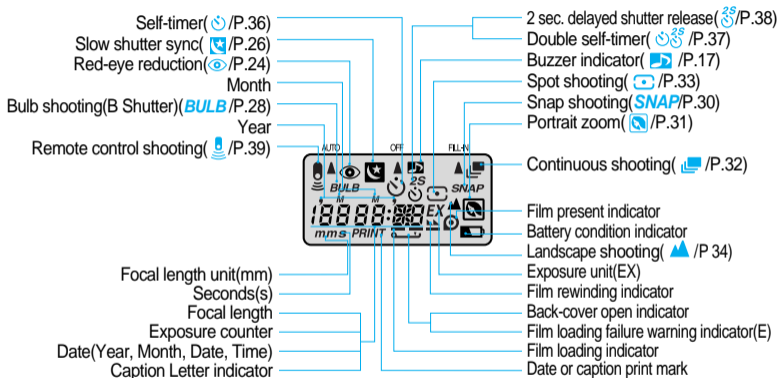

NOTE

- For more information regarding the mark, refer to the pages in ().
- When the back-light control function is selected, the flash will operate regardless of ambient lighting conditions.

VIEWFINDER AND INDICATORS

Viewfinder

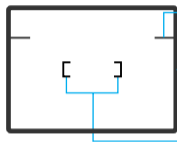

Close range picture area mark

- WIDE : Optimum picture area when shoot within 0.6m~1.2 m
- TELE : Optimum picture area when shoot within 0.9m ~ 3m

Picture area frame

- WIDE : Optimum picture area when shoot over 1.2 m
- TELE : Optimum picture area when shoot over 3m

Autofocus frame (Focus on the subject with this frame)

Indicators

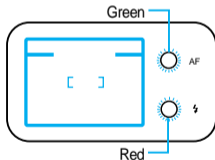

1. Autofocus Indicator (Green LED)

- When illuminated this confirms that conditions are suitable for picture taking.
- When the subject is too close, (within 0.6m (1.97ft), the LED will blink rapidly and the shutter will lock. (Refer to page 17 for information of buzzer operation)
- The Auto Macro mode will be selected when the subject is within the range (0.6m ~ 1.2m). At this point the LED will blink slowly.

2. Flash Indicator (Red LED)

- Illuminates when the flash is fully charged. (In low light conditions)
- Blinks rapidly when the flash is being charged. (Shutter will be locked)
- It blinks quickly if you are out of the range.
- Blinks slowly to indicate that the camera requires steady support (preferably a tripod) to avoid camera shake.

LOADING THE BATTERY

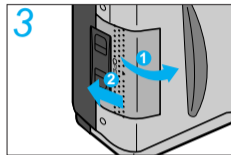
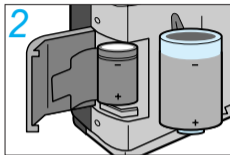
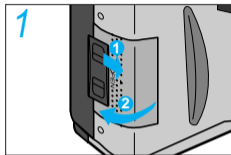



1. Open the chamber cover by sliding the battery chamber cover.
2. Insert a new battery and ensure it is placed in the correct position.
3. Close the chamber cover.

NOTE

- Use one CR-123A or DL-123A battery.
- The camera will automatically turn the power off when not used after 3 minutes. Remove the battery from the camera when the camera is not used for an extended period.
- Be sure to check the date and shooting mode when you load a new battery.
- If the date or time is incorrect, please refer to page 19 and adjust accordingly.

CHECKING THE BATTERY

- You can check the battery life on the LCD panel

	<ol style="list-style-type: none">1. Normal operation<ul style="list-style-type: none">- The battery condition indicator does not appear.
	<ol style="list-style-type: none">2. The indicator appears half way.<ul style="list-style-type: none">- The battery life is low and you should ensure that a replacement battery is available.
	<ol style="list-style-type: none">3. The indicator blinks.<ul style="list-style-type: none">- The battery is exhausted. Load a new battery.

NOTE

- Do not remove the battery while the camera is operating, because it may cause the camera to malfunction.
- Battery performance is reduced in low temperatures (under -10°C (14°F)); Try to keep the camera warm between shots. (The battery will operate normally again when the temperature returns to normal).
- Please dispose of the exhausted battery with care.
- Some local authorities may require batteries to be disposed of separately from other refuse.



LOADING THE FILM

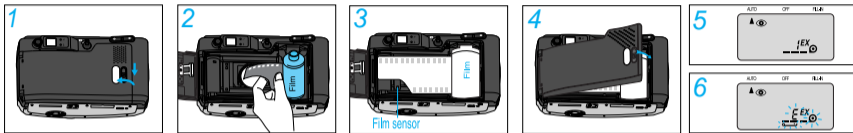

1. Open the back cover by sliding the release knob as shown above.
2. Insert a roll of film in the chamber. Do not force the film into position.
3. The film should lie flat.
4. Close the back cover. It will close with a “click”.
5. The film will automatically advance until the film counter reads “1”.
6. If a film is loaded incorrectly, the LCD panel will display an “E” warning signal. (Refer to page 17 for information of buzzer operation) Reload the film following the steps shown above.

NOTE

- The camera automatically adjusts for ISO 50-3200 DX film.
- When you use non-DX film, the camera will set the film speed at ISO 100.
- Load the film in subdued lighting.

ATTACHING THE STRAP

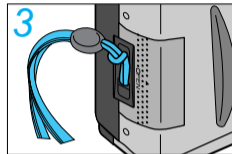
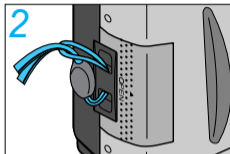
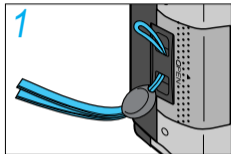

· Refer to the illustrations above.

USING THE CAMERA

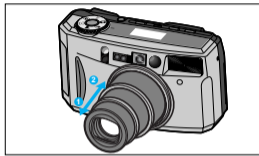
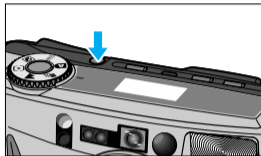

- Press the Power button to turn the power on. The indicators will appear on the LCD panel.
- If the camera is not used for 3 minutes, the power will be turned off automatically.
- While looking through the viewfinder, aim the camera at the subject and operate the zoom buttons.
- Press the “T”(Tele) button to move the lens out ① and press the “W”(Wide) button to move the lens in ②.
- During this operation, the LCD panel shows the focal lengths in the following sequence : 38, 45, 60, 70, 80, 90, 100, 110, 120, 130, 145, 155, 170 mm.

HOLDING THE CAMERA



※ In order to avoid camera shake, hold the camera steady, especially when using longer focal lengths (Tele).

- Place the camera strap over your wrist.
- Both elbows (horizontal picture) or one elbow (vertical picture) should be held close to your body.
- Keep your eye close to the viewfinder when using the camera. This ensures correct framing. Ensure you can see all four sides of the viewing frame when composing your shot.

NOTE

- Avoid obstructing the lens when you take a picture. Pictures can be spoiled when a finger, hair or camera strap falls in front of the Lens, Exposure Sensor or Auto-focus Windows.
- When you take vertical pictures with flash, the flash should be above the lens.

TAKING PICTURES

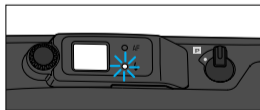
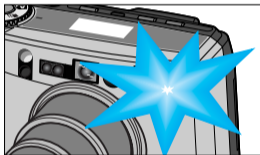
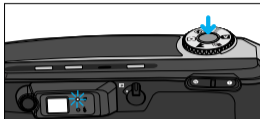

Aim the Autofocus frame at a subject.(Refer to page 8)

- Press the Shutter button half way down. The lens is focused when the green lamp turns on.
- If a subject is between 0.6m (1.97ft) and 1.2m (3.94ft), the green lamp blinks slowly and Macro mode is set automatically.
- If a subject is within 0.6m (1.97ft), the green lamp blinks quickly to indicate that the subject is too close and the shutter is locked. Ensure that the camera/subject distance is 0.6m or more.
- Press the Shutter button all the way down to take a picture.
- The film will automatically advance after shooting and the frame counter will advance.

NOTE

- When the flash is being charged, the flash indicator (► **AUTO**) on the LCD panel blinks and the shutter will not operate.
- When the Red LED blinks slowly, use a tripod or support the camera to avoid camera shake.
- In order to avoid camera shake, hold the camera steadily and press the Shutter button gently, particularly when using longer focal lengths.(Tele)
- After taking pictures, turn off the camera. This will protect the lens and prevent unintended shots. (If not used for 3 minutes, the camera will turn off automatically).
- ※ In such a case, the power will be turn off with zoom lens move into the camera automatically while the Shutter button is operate. If this occur, please turn the power on and take a picture again.

ADJUSTING THE DIOPTER

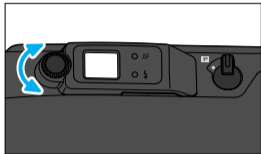

- Select the maximum zoom setting and turn the diopter adjustment dial until the viewfinder display becomes clear.

BUZZER OPERATION

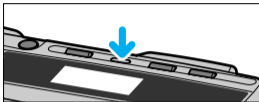

· The buzzer function can be selected by Buzzer ON/OFF button and it will operate only if the buzzer mark appears on the LCD panel.

· According to the function, the buzzer sound is as follows.

Buzzer sound	Function	Application
Peek	Selection	When you press Flash, Self, Buzzer button
1 long beep	Warning	When Mode Dial is changed When Mode Dial is not selected with Auto after the power is turned on
3 short beeps	Warning	When hand shake is detected
3 short beeps	Warning/Error	When AF Lock (shorter than minimum shooting range) occurs When a film is loaded incorrectly When you press Tele/Wide button in the SNAP mode In case of shooting beyond the scope of flash range. (Refer to page 21. The function of Auto Flash zoom compensation)
3 long beeps	Completion	When the rewinding is completely finished

REWINDING THE FILM

1. Automatic rewinding

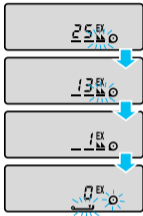

- After taking all the pictures on a roll of film, the camera will automatically rewind the film. The motor stops when the rewinding is completed.
- When the rewinding is completed, the icon () will blink. After 5 seconds the icon will no longer be displayed. You may remove the film at this point. (Refer to page 17 for information of buzzer operation)

2. Mid-roll rewinding

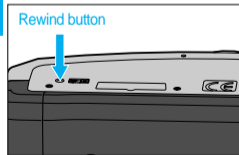

- To rewind the film in the middle of a roll, press the Mid-roll rewind button. The film will be completely rewound, ready for processing. You will not be able to reload the film.

NOTE

- If you press the Shutter button during film rewinding, the rewinding is interrupted until the Shutter button is released.
- If the motor stops before the LCD shows "0", replace the battery. Do not open the back cover until the battery is replaced.

DATE AND CAPTION (Q.D.MODEL ONLY)

- Use the DATE button to control "Date" and "Caption"

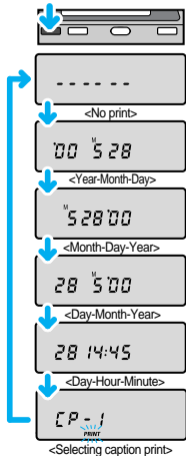

1. Changing "Date" format or selecting the caption

- Press the DATE button to select one of the different formats. (Refer to the left sequences)
- The "PRINT" mark on the LCD panel will blink during the print.

2. Date Zone



<Normal picture>



<Panorama shot>

NOTE

- Under certain circumstances, the date will not print on the final frame of a film.

3. Changing the date setting

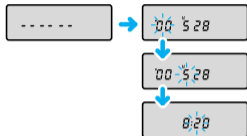

- To change the date or time, press and hold down the DATE button for 2 seconds. The first sector of the date format will blink.
- To select the sector that you want to change, press the DATE button.
- Change the date setting by operating Zoom buttons. TELE button to increase, WIDE button to decrease.

NOTE

- This camera will set the date automatically until 2098.
- A year mark will be indicated by the last 2 digits on the LCD panel. It will be indicated by 4 digits on the picture.
- Under these circumstances the camera will operate as normal.

Example:

1999 → "99"
2000 → "00"
2001 → "01"

4. Selecting the caption print

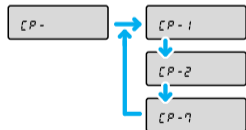

- When the LCD panel shows "CP-1"(refer to the previous picture), you can select one of seven captions as follows :
- To change the captions, operate the zoom buttons. ("T" or "W")
- When caption Mode is selected, message caption will appear on the LCD panel in order.

NOTE

- The camera will print either a date or a caption. You cannot select both date and caption on the same picture. (The caption is printed on the date zone).
- Remember to reset the date and time after changing the battery.

MESSAGE CAPTIONS

CP-1	I LOVE YOU!
CP-2	A HAPPY BIRTHDAY
CP-3	THANK YOU
CP-4	CONGRATULATIONS
CP-5	A HAPPY NEW YEAR
CP-6	MERRY X-MAS
CP-7	HELLO!

USING THE FLASH MODE

- You can select the flash mode by pressing the FLASH button.

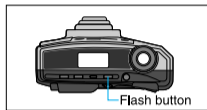
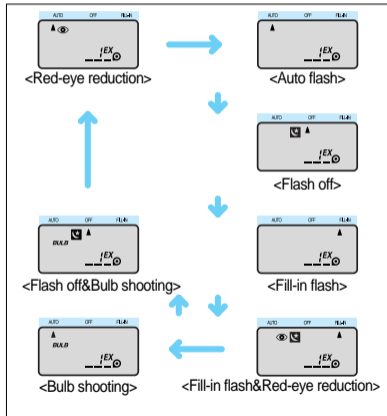

NOTE

- After you shoot once with the "Bulb shooting" mode or "Flash off & Bulb shooting" mode, the camera will return to normal mode automatically.
- In case of the "Auto Flash" function, the camera will retain the mode even though the camera is turned off. When you turn on the camera, check the LCD panel.

※ THE FUNCTION OF AUTO FLASH ZOOM COMPENSATION

The zoom mode can be changed from TELE to WIDE when the shot mode is on normal shot mode A or on SPOT shot mode under the condition of flash radiation. (Red-eye reduction, Auto Flash, Fill-in Flash) The zoom operates automatically to prevent the pictures from getting too dark.

USING THE SHOOTING MODE

- You can select the shooting mode by turning the dial clockwise or counter-clockwise.
- The lamp beside "Mode Dial" indicates the mode according to the rotation of the dial.

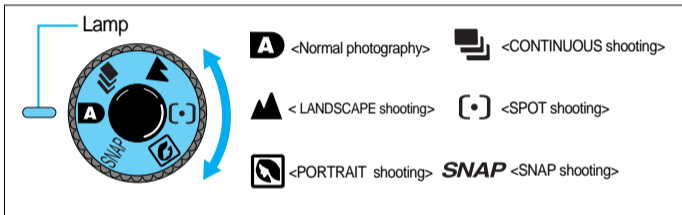

NOTE

- After shooting, the shooting mode will remain selected until another mode is chosen.
- This lamp will not light up if the brightness is LV14 or more.

USING THE SELF MODE

- You can select the self mode by pressing the SELF button.

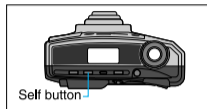
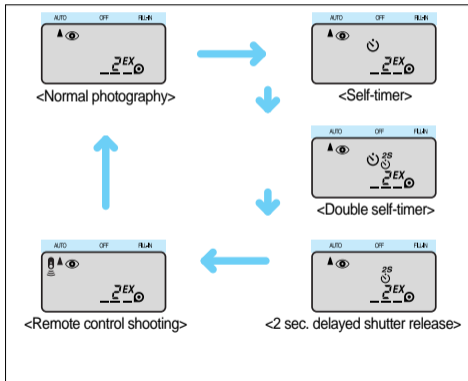

NOTE

- With the "Non Q.D. model", the "Remote control shooting" mode does not appear on the LCD panel.
- After using the "2 sec. Delayed Shutter Release" or "Remote Control Shooting" modes, the camera will remain in that mode, until a new selection is made.

AUTO AUTO RED-EYE REDUCTION

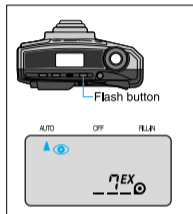

- In low light conditions, the flash will automatically fire to obtain a suitable exposure.
- You can decrease the red-eye phenomenon automatically when taking a portrait picture in low light.



<Auto flash>



<With red-eye reduction>

NOTE

- The red-eye reduction mode dramatically reduce the possible red-eye effect by emitting rapid pre-flash to shrink the subject's pupils before the main flash fires.
Do not allow the subject to move until the main flash has fired.
- Shooting beyond the scope of the flash range will induce the activation of the buzzer and the zoom lens.
(applied to the cases of normal shot mode A, SPOT shot mode)

▶ **AUTO** AUTO FLASH

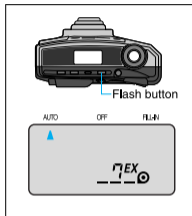

- Select the Auto Mode by pressing the FLASH button 1 times.
- Auto flash mode activates the flash by measuring the brightness of the object.
- Flash will not engage when the shooting object is too bright.

NOTE

- Shooting under poor light might cause the eyes to appear red in the pictures. The red-eye reduction mode will be engaged automatically under poor lighted area.
- Once the Auto Flash Mode is selected, it will remain active even when it is turned off. (but)When you change the battery, the mode will be set to red-eye reduction.
- Shooting beyond the scope of the flash range will induce the activation of the buzzer and the zoom lens.
- In case of the "Auto Flash" function, the camera will retain the mode even though the camera is turned off. When you turn on the camera, check the LCD panel.

OFF FLASH OFF

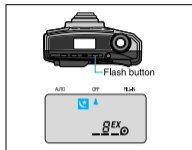

- Select this mode by pressing the FLASH button twice.
- Use this mode when you want to take pictures without flash.

NOTE

- When using the Flash Off function, you may need to use a tripod to avoid camera shake.

FILL-IN FILL-IN FLASH

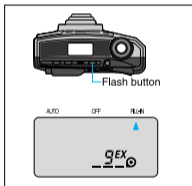

- Select this mode by pressing the FLASH button 3 times.
- When the main subject is in shadow and the surrounding light conditions are too strong for the auto-flash to engage, the fill-in flash allows you to expose the subject correctly.

NOTE

- When using this mode, the flash fires regardless of the brightness of the subject and background.
- Shooting beyond the scope of the flash range will induce the activation of the buzzer and the zoom lens. (applied to the cases of normal shot mode A, SPOT shot mode)



FILL-IN FILL-IN FLASH AND RED-EYE REDUCTION

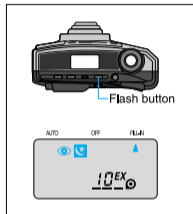

- Select this mode by pressing the FLASH button 4 times.
- Use this mode when you take a picture of a person in low light condition.

NOTE

- Use a tripod to avoid camera shake.



BULB ► AUTO BULB SHOOTING (B SHUTTER)

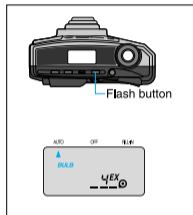

- To shoot subjects that require an extended shutter speed shooting such as Portrait in fireworks and night scenes, use this mode (Bulb shooting) by pressing the Flash button 5 times.
- The shutter remains open as long as the shutter button is depressed. The time selected is shown on the LCD panel and the maximum time is 60 seconds.

NOTE

- Use this mode only in low light.
- To avoid camera shake, use a tripod.
- To prevent of over-exposure from the high brightness, the Bulb shooting mode will not operate even though the mode is selected.



FLASH OFF & BULB SHOOTING (B SHUTTER)

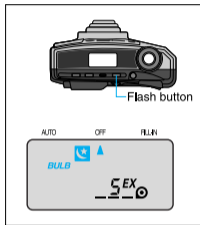

- To shoot subjects that require an extended shutter speed shooting such as fireworks and night scenes, use this mode (Flash off & Bulb shooting) by pressing the Flash button 6 times.
- The shutter remains open as long as the shutter button is depressed. The time selected is shown on the LCD panel and the maximum time is 60 seconds.

NOTE

- Use this mode only in low light.
- To avoid camera shake, use a tripod.
- To prevent over-exposure from the high brightness, the Bulb shooting mode will not operate even though the mode is selected.

SNAP **AUTO SNAP SHOOTING**

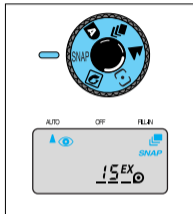

- Select SNAP mode by turning “Mode Dial”.
- Use this mode when taking a picture of active subjects such as children or pets. (They are difficult to focus on)
- When you select this mode, the camera will set the wide position (38mm) and the focus is fixed.
- If you depress the shutter button continuously, the camera will take a sequence of shots.

NOTE

- The subject must be within the range 1.4m ~ 6m (4.6ft ~ 19.7ft).
- Tele/Wide will not operate in the SNAP mode. (Refer to page 17 for the information of buzzer operation)



AUTO PORTRAIT ZOOM

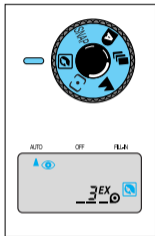

- Select this mode by turning “Mode Dial”.
- Use this mode to maintain a constant subject size within the frame, even though the distance to a subject may vary.
- Position your subject in the centre of the viewfinder and press the shutter button half-way. The zoom will operate automatically to attain the optimum shot.
- Press the shutter button fully to take a picture.



<Normal mode>



<Portrait zoom>

AUTO CONTINUOUS SHOOTING

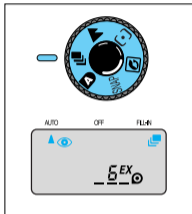

- Select this mode by turning "Mode Dial".
- Use this mode to take a sequence of pictures.
- As long as you press the shutter button, the camera will continue to take pictures.

NOTE

- If flash is required, the time between shots will be increased due to the flash recycling.
- The flash does not fire if no film is loaded (except for "Fill-in Flash" mode).



AUTO SPOT SHOOTING

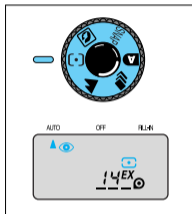

- Use this mode when photographing a specific subject in a situation where the camera may have difficulty in focusing.
- Certain subjects, such as a person in a crowd, can be difficult to photograph.
- This mode enables you to have your specific subject clear, even when surrounded by other subjects in the picture.
- Select SPOT mode by turning “Mode Dial”.
- The camera focuses on the subject in the spot shooting focus frame.

NOTE

- Shooting beyond the scope of the flash range will induce the activation of the buzzer and the zoom lens. (Applicable in Red-Eye Reduction, Fill-in Flash, and Auto Flash.)

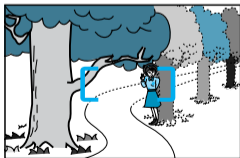

▲ LANDSCAPE SHOOTING

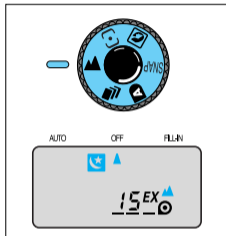

- If you can't shoot clearly distant subjects through a window, use this mode by turning "Mode Dial" to LANDSCAPE mode and pressing the LANDSCAPE button.

NOTE

- With this mode, the flash does not fire.
- Use a tripod to avoid camera shake in low light conditions.
- When LANDSCAPE mode is not in use change this mode into normal mode.



<Without Landscape mode>



<With Landscape mode>

USING THE FOCUS LOCK



- If you want to focus on a subject that is not in the centre of your picture, use the Focus Lock function described below.

1. Aim the camera with the autofocus frame superimposed over the subject.
2. Press the shutter button half way down. (Green LED light)
Be careful not to press the shutter button all the way down to avoid taking an unwanted picture.
3. Keeping the shutter button depressed, recompose your picture as desired.
Hold the camera steadily and gently press the shutter button completely down.
The Focus Lock can be released at any time by lifting your finger from the shutter button.

ATTENTION

The Autofocus system of this camera may not function in circumstances below :

- The subject blends into the background.
- The subject is fast moving.
- The subject does not reflect enough light back into the autofocus receiver (e.g. very dark objects).
- The subject is very narrow, either horizontally or vertically (e.g. a lamppost).
- There is more than one subject, one near the camera and one some distance away.
- Strong light is directed at the camera. (the subject is back lit).
- Fireworks and smoke.
- Shining or glossy surfaces such as a car body or the surface of water.

In these circumstances, using the Focus Lock feature may help to solve the problem.

AUTO SELF-TIMER

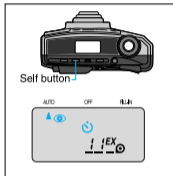

- This can be selected by pressing the SELF button once. You can take a picture of yourself by using this mode.
- When pressing the shutter button, the self-timer lamp illuminate for 7 seconds. Then the lamp blinks rapidly for 3 seconds and the picture is taken.

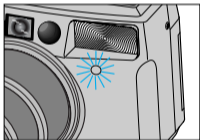

AUTO DOUBLE SELF-TIMER

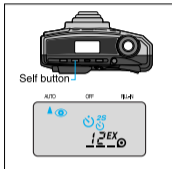

- You can select this mode by pressing the SELF button twice.
- Press the shutter button and a shot will be taken in the same way a self timer shot is taken. A further shot will be made after 2 seconds.

NOTE

- When using the flash, the shooting interval may increase due to the flash recharging time.

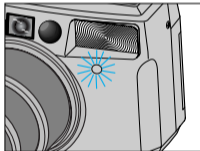

AUTO 2 SEC. DELAYED SHUTTER RELEASE

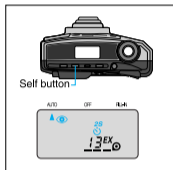

- Use this mode to avoid camera shake caused by camera movement during hand held shots.
- In this mode, a picture is taken 2 seconds after releasing the shutter button.
- To use this mode, place the camera on a steady surface, select by pressing the SELF button 3 times before taking the picture.



AUTO REMOTE CONTROL SHOOTING (OPTIONAL)

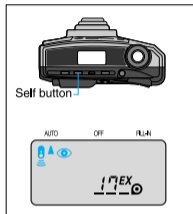

- Select this mode by pressing the SELF button 4 times. (You can only use this function with the Q.D. model camera)
- When you select this mode, the self-timer lamp will blink every 2 seconds.
- To take a picture using a remote control, press the Remote Control shooting button. The camera will take a picture after two seconds.

Names of parts of the Remote Control

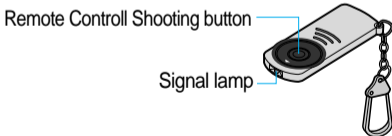

REPLACING THE BATTERY OF THE REMOTE CONTROL (OPTIONAL)

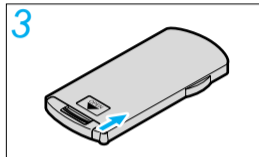
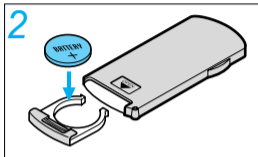
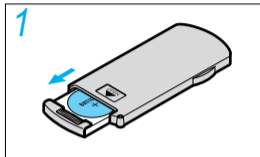

Replacing the battery

- Refer to the illustrations above.

NOTE

- Use one lithium battery (JIS CR2025)
- Be sure to place a battery in the correct position. The positive contact (+) must be facing up.

AUTO MACRO PHOTOGRAPHY

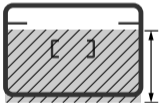
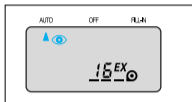

Super Macro range picture area

- When a subject is within 1.2m (3.94ft), the camera will automatically set this mode.
- Close range picture area is as below:
WIDE : 0.6 ~ 1.2m (1.97 ~ 3.94ft)
TELE : 0.9 ~ 3m (2.95 ~ 9.84ft)
- In the case of super Macro tele - photographing (0.9 ~ 1m), you have to set your camera under the slash markings, as there can be so much difference of visual rate according to the location of photographer's eyes.
- When a subject is out of range, the Autofocus Indicator (Green LED) will blink quickly. When a subject is within range, it will blink slowly. (Refer to page 17 for the information of buzzer operation)
- Remember to compose your shot using the macro picture area frame.(Refer to page 8)

NOTE

- When a subject is closer than 0.6m (1.97ft), the Green LED will blink quickly and the shutter will lock.
- MACRO should use close range picture area mark because close range picture area includes MACRO picture area.

PANORAMA PHOTOGRAPHY

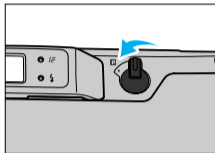

- Use this mode to capture a panoramic view.
- When you set this mode, the viewfinder will alter to indicate the panoramic scene.
- The picture area with this mode will be narrowed.
- Select this mode using the PANORAMA switch. The PANORAMA mode can be used on selected frames in a film.
- Remember to inform your processor that some shots are panoramic. There may be an extra charge for this service.

NOTE

- The date can be imprinted with this mode.(Q.D. model only-Refer to page 19)



<Normal>



<Panorama>

CARE AND STORAGE

- If your camera needs cleaning, wipe it with a soft, lintless cloth.
 - The lens should be cleaned only with special lens cleaning tissue and fluid.(Consult your camera retailer.)
 - Do not allow your camera to come into contact with sand or water.
 - Keep your camera in a dry, cool place that is free from high humidity and dust.
 - Never leave your camera in hot places such as a parked car, or direct sunlight.
- Avoid sudden shocks or vibration. If you drop your camera, it is a good idea to have it checked before using it.

Warning

- Do not try to disassemble the camera yourself.
Your camera contains high voltage circuitry and may cause injury if interfered with.
 - The temperature range in which the camera operates is between 50 °C and -10 °C (122°F~14 °F).
 - The camera performance may be impaired when used in very cold weather. If you plan to take pictures when the temperature is below 7 °C(45°F), take care to keep your camera and battery warm between shots. If your camera becomes very cold, allow it to return to room temperature slowly by keeping it in its case. Condensation can spoil pictures and in extreme conditions can damage the electronic components inside the camera.
- ※ If you have trouble with your camera, please return it to your retailer for advice.

TROUBLE SHOOTING

- If the shutter does not operate after pressing the shutter button.

Check point	Remedy	Page
Is the lens cover completely open?	Press the Power button again.	13
Is the battery loaded correctly?	Reinsert correctly.	9
Has it been a long time since you used the camera?	Change the battery.	10

- If a picture is partially dark or out of focus.

Check point	Remedy	Page
Was the lens or other sensors obstructed by your fingers or hair ?	Be careful not to block the lens or the exposure sensor.	14
Did you compose a subject correctly referring to the picture area frame?	Read the "Viewfinder and Indicators"	8
Did you set the camera to the panorama mode?	Release the panorama mode.	42

SPECIFICATIONS

TYPE	35mm fully automatic lens shutter camera.	
FILM	Format	35mm DX-coded film, 24x36mm
	Speed	Automatic setting with DX-coded film, ISO 50~3200
	Loading	Automatic advance to the first frame when the back cover is closed.
	Winding	Automatic advance, Single or Continuous shooting
	Rewinding	Automatic rewinding, Mid-roll rewinding
LENS	Schneider lens F4.7~13.5 / 38-170mm 10 elements 7 groups (2 elements of Aspherical lens)	
SHUTTER	Programmed AE electronic focusing Shutter speed : 1/3 ~ 1/400 sec. Bulb mode(B shutter) : 60 ~ 0.5 sec.	
EXPOSURE	Programmed auto exposure AE coupling range (ISO 100 film) · WIDE(38mm) : EV 6.0~18.6 · TELE(170mm) : EV 9.1~18.6	
VIEWFINDER	Real image type with autofocus frame Field of view : 83% Magnification : 0.45~1.7 Picture area frame mark Connection with Panorama switch	

FLASH	Type	Built-in electronic flash
	Range	WIDE(38mm) : 0.6 ~ 4.4m(1.97 ~ 14.14ft) TELE(170mm) : 0.9 ~ 2.1m(2.95 ~ 6.89ft)
	Recycling time	Approx. 6~8 sec.
SPECIAL FEATURES	Shooting mode	<ul style="list-style-type: none"> · PORTRAIT zoom · CONTINUOUS shooting · LANDSCAPE shooting ; WIDE(38mm):3.5m~ ∞(11.5ft~ ∞), TELE(170mm):16m~ ∞(52.5ft~ ∞) · SPOT shooting · SNAP shooting(between 1.4~6.0m (4.6~19.7ft))
	Flash mode	<ul style="list-style-type: none"> · Red-eye reduction · Auto flash · Flash off · Fill-in flash · Fill-in flash & Red-eye reduction · Bulb shooting(B Shutter) · Flash off & Bulb shooting
	Autofocus mode	· Passive multi autofocus
	Self mode	· Single/Double self-timer · 2 sec. delayed shutter release · Remote control(Optional)
		· Panorama mode (Switchable)
DATE AND CAPTION (Q.D.model only)	Date or Time setting - 5 different formats (The camera will set the date automatically until 2098.) Captions imprint-7 different messages	
POWER SOURCE	One 3V lithium battery (CR 123A)	
DIMENSIONS(WxHxD)	116 x 65 x 51mm / 4.56 x 2.6 x 2in	
WEIGHT	270g / 9.5oz (without battery)	

- Specifications are subject to change without prior notice.
- All data are based on SAMSUNG'S standard test methods.

CHECKING THE CAMERA

●Checking the shutter condition

- You can check the condition of the shutter by pressing it.
The short “click” sound will result.

●Checking the irises

- After removing the back cover of a camera, it is normal to see the closed lens opening up when you press the shutter.
- The irises will adjust depending on the light condition.
Dark light will cause them to open wide; bright light will cause the narrowing of the irises.

- If the irises were opened before pressing the shutter or cannot be opened, the irises are not operating properly.

●Film transferring device

- It is normal to hear the motor running after you open and close the camera cover.
- It is normal to hear the motor running after you press the Mid-roll rewinding button.
- After examining the Mid-roll rewinding condition, set the camera to the default state and check other functions.

●Flash Activation

- Check the Auto Flash Mode indoors.

※ It is important to check your camera prior to up-coming event to prevent possible psychological and monetary damage once the camera is not working properly at the day of the event.

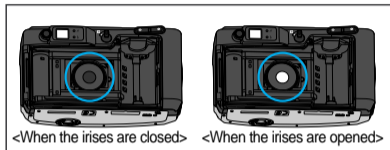

The Samsung logo, consisting of the word "SAMSUNG" in white, bold, sans-serif capital letters, centered within a blue, horizontally-oriented oval shape.

SAMSUNG TECHWIN CO., LTD.
OPTICS & DIGITAL IMAGING DIVISION
145-3, SANGDAEWON 1-DONG,
JUNGWON-GU, SUNGNAM-CITY,
KYUNGKI-DO, KOREA 462-121
TEL : (82) 31-740-8086,8088, 8090,
8092, 8099
FAX : (82) 31-740-8398, 8399

SAMSUNG OPTO-ELECTRONICS AMERICA, INC.
HEADQUARTERS
40 SEAVIEW DRIVES, SECAUCUS, NJ07094
TEL : (1) 201-902-0347
FAX : (1) 201-902-9342
WESTERN REGIONAL OFFICE
18600 BROADWICK ST.,
RANCHO DOMINGUEZ, CA 90220
TEL : (1) 310-537-7000
FAX : (1) 310-537-1566

SAMSUNG U.K. LTD.
PHOTO PRODUCTS DIV.
SAMSUNG HOUSE, 3 RIVERBANK WAY,
GREAT WEST ROAD, BRENTFORD,
MIDDLESEX, TW8 9RE, U.K.
TEL : (44) 181-232-3278
FAX : (44) 181-569-8385

SAMSUNG DEUTSCHLAND GmbH
SAMSUNG HAUS
AM KRONBERGER HANG 6, 65824 SCHWALBACH,
GERMANY
TEL : (49) 61-96-66 53 01
FAX : (49) 61-96-66 53 33

SAMSUNG FRANCE S.A.R.L.
BP. 51 TOUR MAINE-MONTPARNASSE 33,
AV DU MAINE 75755,
PARIS CEDEX 15, FRANCE
TEL : (33) 1-4279-2283
FAX : (33) 1-4320-4510

S.MARKET.COM.IMP.EXP.LTDA
RUA ALFERES MAGALHÃES, 92 CONJUNTO 71 SANTANA
SÃO PAULO-SP BRAZIL 02034-000
TEL/FAX : (55) 11-6221-6833

SAMSUNG TECHWIN MOSCOW OFFICE
KOSMODAMIANSKAYA NABEREZNAYA 40/42,
MOSCOW, 113035, RUSSIA
TEL/FAX : (7) 095-937-79-50

SAMSUNG AUSTRALIA PTY. LTD.
LEVEL 33, NORTHPOINT BLDG, 100 MILLER
STREET, NORTH SYDNEY,
NSW 2060, AUSTRALIA
TEL : (61) 2-9955-3888
FAX : (61) 2-9955-4233

TIANJIN SAMSUNG OPTO-ELECTRONICS CO.,LTD.
7 PINGCHANG ROAD NANKAI DIST. TIANJIN
P.R CHINA
POST CODE:300190
TEL : (86)22-2761-4599
FAX : (86)22-2761-3314

* Internet address - <http://www.samsungcamera.com/>



The CE Mark is a Directive conformity
mark of the European Community (EC)

6806 - 0961(N)