

FUJIFILM

digital
Tools for the imagination.

DIGITAL CAMERA

FinePix A201

2.0
MEGA
PIXELS



Getting Ready

1

Basic Photography

2

Advanced Features
Photography

3

Advanced Features
Playback

4

Settings

5

PC Connection

6

OWNER'S MANUAL

This manual will show you how to use your FUJIFILM DIGITAL CAMERA FinePix A201 correctly. Please follow the instructions carefully.

BL00095-200 (1)



Warning

To prevent fire or shock hazard, do not expose the unit to rain or moisture.

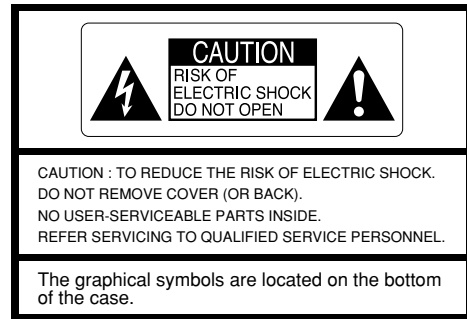

This symbol is intended to alert the user to the presence of uninsulated “dangerous voltage” within the product’s enclosure that may be of sufficient magnitude to constitute a risk of electric shock to persons.



This symbol is intended to alert the user to the presence of important operating and maintenance (servicing) instructions in the literature accompanying the appliance.

For customers in the U.S.A.

FCC Statement

This device complies with part 15 of the FCC Rules. Operation is subject to the following two conditions : (1) This device may not cause harmful interference, and (2) this device must accept any interference received, including interference that may cause undesired operation.

CAUTION

This equipment has been tested and found to comply with the limits for a Class B digital device, pursuant to Part 15 of the FCC Rules. These limits are designed to provide reasonable protection against harmful interference in a residential installation. This equipment generates, uses, and can radiate radio frequency energy and, if not installed and used in accordance with the instructions, may cause harmful interference to radio communications. However, there is no guarantee that interference will not occur in a particular installation. If this equipment does cause harmful interference to radio or television reception, which can be determined by turning the equipment off and on, the user is encouraged to try to correct the interference by one or more of the following measures :

- Reorient or relocate the receiving antenna.
- Increase the separation between the equipment and receiver.
- Connect the equipment into an outlet on a circuit different from that to which the receiver is connected.

— Consult the dealer or an experienced radio/TV technician for help.

You are cautioned that any changes or modifications not expressly approved in this manual could void the user’s authority to operate the equipment.

Notes on the Grant:

To comply with Part 15 of the FCC rules, this product must be used with a Fujifilm-specified ferrite-core USB cable and DC supply cord.

For customers in Canada

CAUTION

This Class B digital apparatus complies with Canadian ICES-003.

Please read the Safety Notes (→P.81) and make sure you understand them before using the camera.

Contents

Warning	2
Preface	6
Camera Features and Accessories	7
Nomenclature	8

1 Getting Ready

PREFACE	11
Selecting the Language	11
Attaching the Strap	11
LOADING THE BATTERIES	12
LOADING THE SmartMedia™	13
REMOVING THE SmartMedia™	14
SWITCHING ON AND OFF	15
SETTING THE DATE AND TIME	16
USING THE OPTIONAL AC POWER ADAPTER	18

2 Basic Photography

STILL IMAGE MODE

■ TAKING PICTURES (AUTO MODE)	19
■ Viewfinder Lamp Display	21
Number of Available Shots	22
FRAMING GUIDELINE FUNCTION	23
🔍 MACRO (CLOSE-UP) PHOTOGRAPHY	24
DIGITAL ZOOM	25
4 ▶ VIEWING YOUR IMAGES (PLAYBACK)	26

PLAYBACK ZOOM	27
MULTI-FRAME PLAYBACK	28
ERASING SINGLE FRAME	29

3 Advanced Features Photography

ADVANCED FEATURES PHOTOGRAPHY	31
■ Photography mode specifications	31

STILL IMAGE MODE

SELECTING QA AUTO OR QM MANUAL	32
--	----

PHOTOGRAPHY MENU

PHOTOGRAPHY MENU OPERATION	33
⚡ FLASH	34
AUTO Auto Flash Mode	34
👁 Red-Eye Reduction	35
⚡ Forced Flash	35
🚫 Suppressed Flash	36
S⚡ Slow Synchro	36
🕒 SELF-TIMER PHOTOGRAPHY	37
📷 EV (EXPOSURE COMPENSATION)	39
WB WHITE BALANCE (SELECTING THE LIGHT SOURCE)	40
MOVIE MODE	
🎬 MOVIE	41

4 Advanced Features Playback

PLAYING BACK MOVIES	44
■ Playing back movies	45

PLAYBACK MENU

🗑 ERASING SINGLE • ALL FRAMES/FORMATTING	46
🖨 HOW TO SPECIFY PRINT OPTIONS	48
📅 DPOF DATE SETTING	49
📅 DPOF SET FRAME	50

5 Settings

SETTINGS	52
■ List of settings	52
■ SET-UP menu options	52
USING THE OPTION MENU	53
Using SET-UP	53
SET ⚙ SETTING THE FILE SIZE AND QUALITY (COMPRESSION RATIO)	54
SET 📺 LCD MONITOR BRIGHTNESS	55
SET-UP	
POWER SAVE	56

6 PC Connection

IN PC CONNECTION	57
DSC (Mass storage device) Mode	57
PC-CAM (camera) Mode	57
CONNECTING AT DSC (MASS STORAGE DEVICE) MODE	58
CONNECTING AT PC-CAMERA MODE	60
DISCONNECTING FROM THE PC (Important – always use this procedure.)	62

System Expansion Options	64
Accessories Guide	65
Notes on Using Your Camera Correctly	67
Notes on the Power Supply	68
Applicable Batteries	68
Notes on the Batteries	68
Notes on Using the AC Power Adapter	70
Notes on the SmartMedia™	71
Warning Displays	73
Troubleshooting	75
Specifications	78
Explanation of Terms	80
Safety Notes	81
EC Declaration of Conformity	84

1

2

3

4

5

6

5

Preface

■ Test Shots Prior to Photography

For particularly important photographs (such as weddings and overseas trips), always take a test photograph and view the image to make sure that the camera is functioning normally.

- Fuji Photo Film Co., Ltd. cannot accept liability for any incidental losses (such as the costs of photography or the loss of income from photography) incurred as a result of faults with this product.

■ Notes on Copyright

Images recorded using your digital camera system cannot be used in ways that infringe copyright laws without the consent of the owner, unless intended only for personal use. Note that some restrictions apply to the photographing of stage performances, entertainments and exhibits, even when intended purely for personal use. Users are also asked to note that the transfer of memory cards containing images or data protected under copyright laws is only permissible within the restrictions imposed by those copyright laws.

■ Liquid Crystal

If the LCD monitor or display panel is damaged, take particular care with the liquid crystal in the monitor or panel. If any of the following situations arise, take the urgent action indicated.

- If liquid crystal comes in contact with your skin
Wipe the area with a cloth and then wash thoroughly with running water and soap.
- If liquid crystal gets into your eye
Flush the affected eye with clean water for at least 15 minutes and then seek medical assistance.
- If liquid crystal is swallowed

6 Flush your mouth thoroughly with water. Drink large

quantities of water and induce vomiting. Then seek medical assistance.

■ Notes on Electrical Interference

If the camera is to be used in hospitals or aircrafts, please note that this camera may cause interference to other equipment in the hospital or aircraft. For details, please check with the applicable regulations.

■ Handling Your Digital Camera

This camera contains precision electronic components. To ensure that images are recorded correctly, do not subject the camera to impact or shock while an image is being recorded.

■ Trademark Information

- IBM PC/AT is a registered trademark of International Business Machines Corp. of the U.S.A.
- iMac and Macintosh are registered trademarks of Apple Computer, Inc.
- Windows is a registered trademark of the Microsoft Corporation of the U.S. registered in the U.S.A. and other countries. Windows is an abbreviated term referring to the Microsoft Windows Operating System.
- SmartMedia is a trademark of Toshiba Corporation.
- Other company or product names are trademarks or registered trademarks of the respective companies. Trademark Information.

Camera Features and Accessories

Features

- Superb high-quality images from the 2.0-megapixel CCD with RGB Filter and high-resolution Fujinon lens.
- Maximum recording resolution of 1600 × 1200 pixels (1.92 million pixels)
- Compact and lightweight body
- Wide range of photography applications (includes Macro function)
- Automatic scene recognition, auto white balance and AE functions built in
- Automatic high-precision flash built in with extensive flash control functionality
- 2.5× digital zoom photography and up to 5× zoom playback functions
- Easy operation using the Mode switch and 4-way “▲▼◀▶” button
- Shoots movies (320 × 240 pixels without sound)
- USB connection for quick and easy image file downloading (using the enclosed Interface Set)
- Built-in PC Camera function
- Runs on 2 ordinary AA batteries
- Conforms to the new standard for digital camera file system*
* Design rule for Camera File system.

Accessories

● LR6 AA-size alkaline Batteries (2)

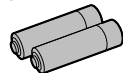

● 16 MB, 3.3V SmartMedia (1)

- Supplied with:
 - Anti-static case (1)
 - Index labels (1)

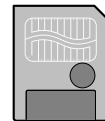

● Hand strap (1)



● Interface Set (1)

- CD-ROM: Software for FinePix VE (1)
- Special USB cable with Noise Suppression core (1)
- Software Quick Start Guide (1)

● Owner's Manual (this manual) (1)

Nomenclature

* Refer to the pages in parentheses for information on using the camera features.

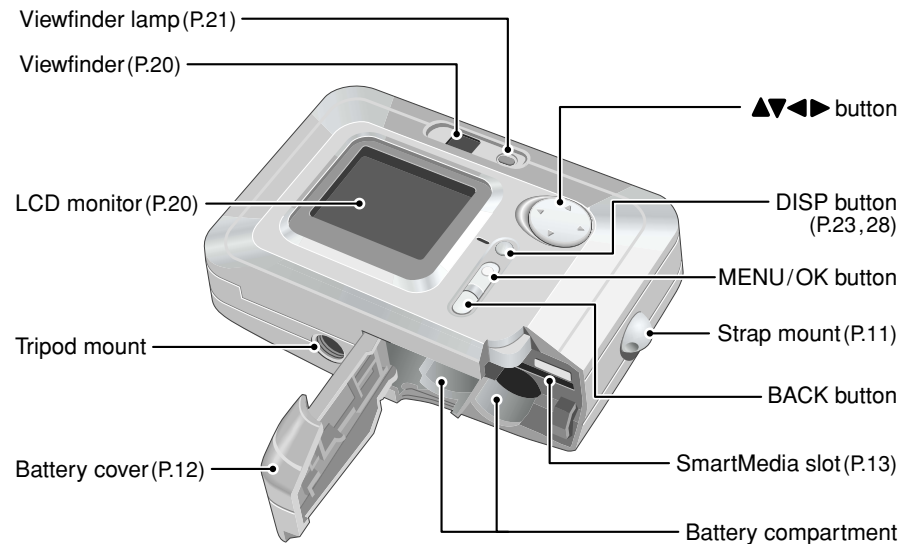
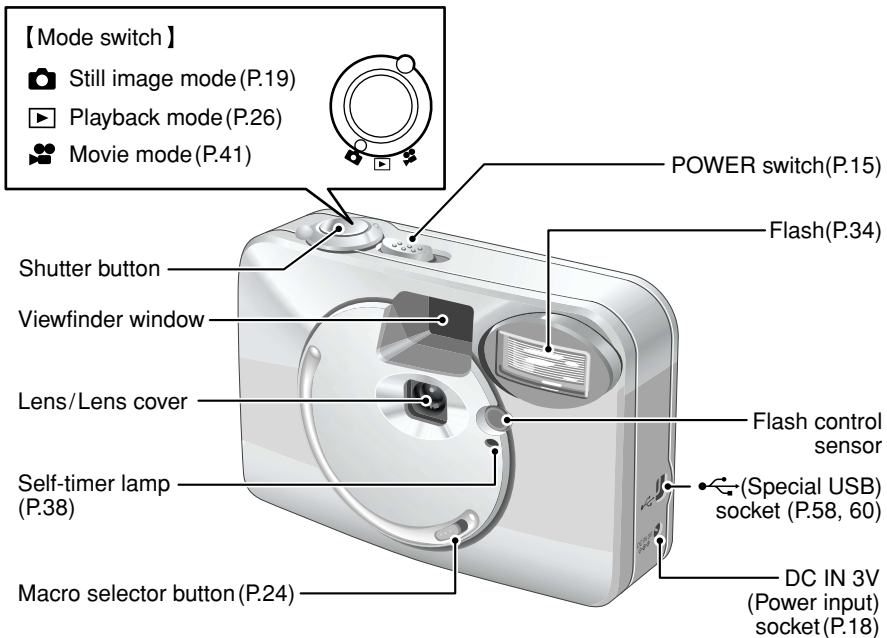

Example of LCD Monitor Text Display : Still image

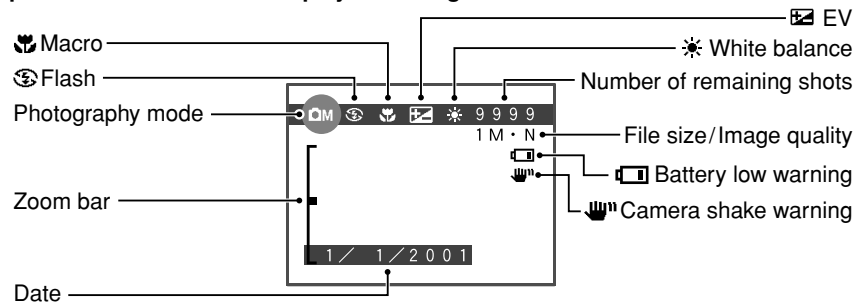

Example of LCD Monitor Text Display : Playback

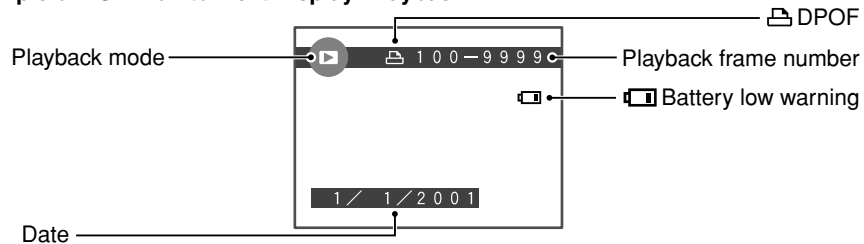

Selecting the Language

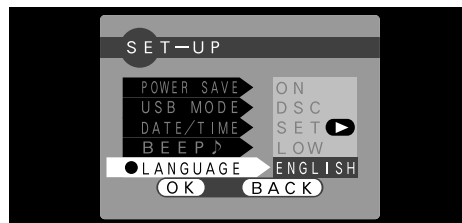

You can use the “SET-UP” screen on this camera to select ENGLISH or FRENCH as the LANGUAGE used for screen display (→P.52). The screens in this manual are shown in ENGLISH.

Attaching the Strap

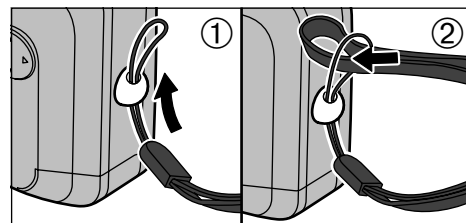

- ① Pass the loop of this cord on the end of the strap through the strap mount.
- ② Then pass the other end of the strap through the loop of the thin cord and pull the strap tight.

LOADING THE BATTERIES

Compatible batteries

Use two AA-size alkaline batteries or two AA-size nickel-metal hydride (Ni-MH) batteries.

◆ Notes on Handling Batteries ◆

- It is recommended that you use same brand of alkaline batteries as those supplied with the camera.
- Do not use different types of batteries or old and new batteries together.
- You cannot use lithium, manganese or nickel-cadmium (Ni-Cd) batteries.
- The operating lives of alkaline batteries vary between brands and the life of batteries you purchase may be shorter than the alkaline batteries provided with the camera. Note also that due to the nature of alkaline batteries, the time for which they can be used is shorter in cold locations (at temperatures of +10°C (+50°F) or below). Consequently, Ni-MH batteries are recommended.
- Soiling (fingerprints, etc) on the terminals of batteries can greatly reduce the time for which the batteries provide power.
- You will need the optional charger (⇒P.65) to recharge Ni-MH batteries.
- See P.68 for notes on using batteries.

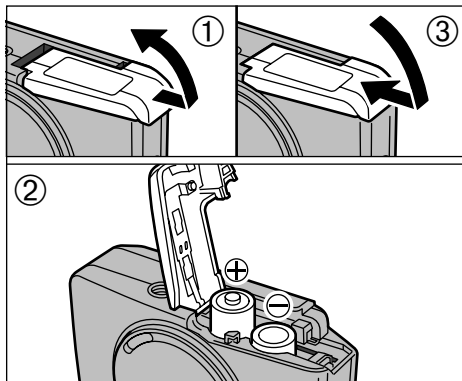

- ① Slide the battery cover out and lift it open.
- ② Insert the batteries correctly as indicated by the polarity icons.
- ③ Close the battery cover.

- ⚠ Do not apply excessive force to the battery cover.
- ⚠ Take care not to drop the batteries when you open or close the battery cover.
- ⚠ You should carry a spare set of batteries (sold separately) when taking pictures.

LOADING THE SmartMedia™

SmartMedia™ (sold separately)

■ Only use 3.3V SmartMedia

MG-4S (4MB), MG-16SW (16MB, ID)
MG-8S (8MB), MG-32SW (32MB, ID)
MG-16S (16MB), MG-64SW (64MB, ID)
MG-32S (32MB), MG-128SW (128MB, ID)
MG-64S (64MB)

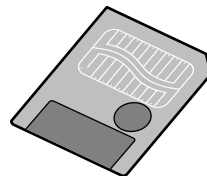

- ⚠ Image files cannot be recorded or erased if a write-protect sticker is affixed to the SmartMedia.
- ⚠ Operation of this camera is only guaranteed when it is used with FUJIFILM SmartMedia.
- ⚠ Some 3.3V SmartMedia are labelled as "3V" or "ID" cards.
- ⚠ See P.71 – 72 for more information on SmartMedia.

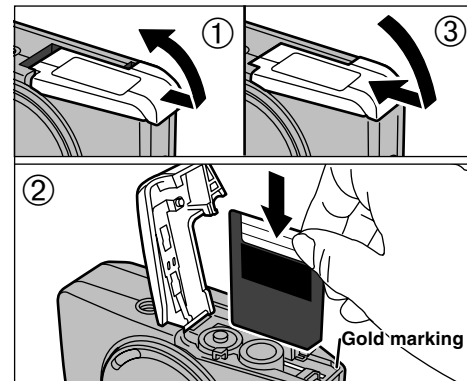

- ① Check that the camera is switched off. Then hold the camera so that the battery cover faces upwards and slide the cover out to open it.
- ② Push the SmartMedia firmly into the SmartMedia slot as far as it will go.
- ③ Close the battery cover.

- ⚠ If you open the battery cover while the camera is still switched on, the camera is automatically switched off to protect the SmartMedia.
- ⚠ The SmartMedia will not slide fully into the slot if it is inserted facing the wrong way. Be careful not to apply undue force to the SmartMedia.

REMOVING THE SmartMedia™

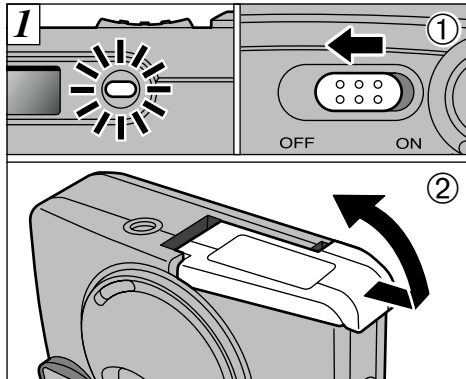

- ① Check that the indicator in the viewfinder is green and then switch the camera off.
- ② Always ensure that the battery cover is facing upwards when you open it.

Never open the battery cover while the camera is still switched on as this could corrupt the image files on the SmartMedia or damage the SmartMedia itself.

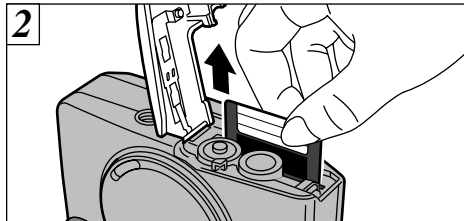

Grip the SmartMedia and pull it out, taking care that the batteries do not fall out of the camera.

- ⚠ To protect the SmartMedia, always store it in the special anti-static case.

◆ Printing Images and Downloading Images to a PC ◆

- See P.48, 64 for information on printing images.
- See P.57 – 63 for information on downloading images to a PC.

SWITCHING ON AND OFF

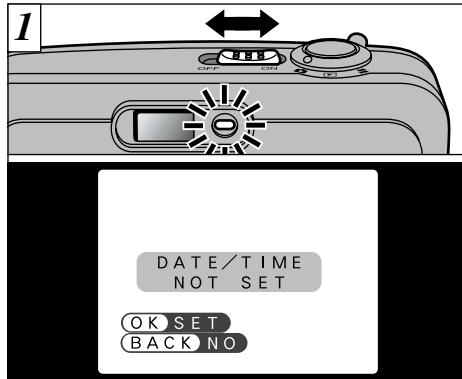

To switch the camera on and off, slide the “POWER” switch sideways. When you switch the camera on, the viewfinder lamp lights (green). If the date has been cleared, a confirmation message appears.

(OK): The DATE/TIME setting screen appears (→P.17).

(BACK): The camera remains in Still image, Movie or playback mode.

- ⚠ If you do not set the date and time, this confirmation screen will appear each time you switch the camera on.
- ⚠ Take care not to touch the lens when you switch the camera on as the lens cover opens when the camera is switched on.

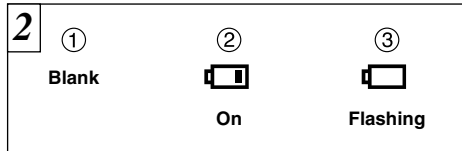

With the LCD monitor on, you can check the remaining charge in the battery.

- ① Battery has ample charge (No indicator displayed).
 - ② The battery charge is low. Have a new set of batteries ready.
 - ③ The battery is exhausted. The display will shortly go blank and the camera will stop working. Replace or recharge the battery.
- ⚠ In Still Image mode, the LCD monitor stays off when you switch the camera on. See P.23 for information on switching the LCD monitor on.
 - ⚠ If the battery charge is depleted, you may not be able to switch the LCD monitor on.

◆ Power Save Function ◆

If the camera is not used for 2 minutes, this function automatically switches it off. When this function is enabled, the LCD monitor switches off to conserve battery power if the camera is not used in any way for 30 seconds (See P.56 for details).

SETTING THE DATE AND TIME

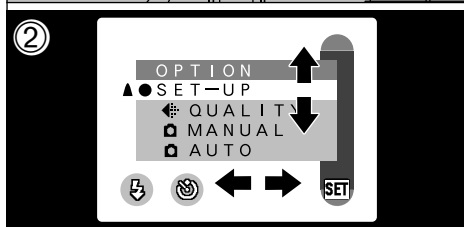
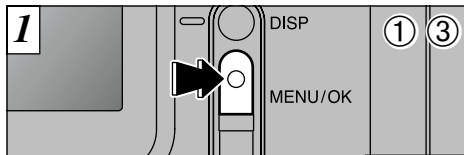

- ① Press the "MENU/OK" button to display the menu screen.
- ② Use "◀▶" button or "▲▼" to select "SET-UP" from the "OPTION" menu.
- ③ Press the "MENU/OK" button.

If the date was cleared and you selected "OK", proceed from step ③ (→P.17).

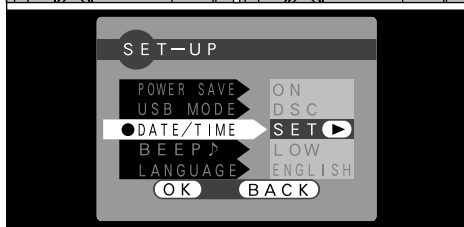
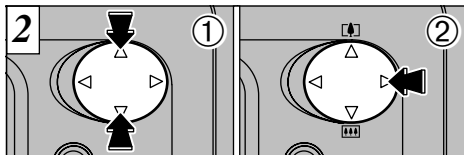

- ① The "SET-UP" screen appears. Use "▲" or "▼" to select "DATE/TIME".
- ② Press "▶".
- ⚠ See P.52 for more information on the "OPTION" menu.
- ⚠ If at least 10 minutes have passed since the AC power adapter was connected or the battery inserted and date and time set, then those settings will be maintained for roughly 12 hours even when the camera has no power supply (when the AC power adapter is disconnected and the battery is removed).

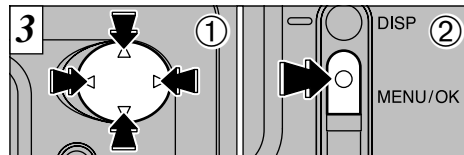

- ① Use "◀" or "▶" to select the desired item and then use "▲" and "▼" to correct the setting.
- ② When you have finished setting the date and time, press the "MENU/OK" button to confirm the setting.
- ⚠ If you hold down "▲" or "▼", the numbers change continuously.
- ⚠ When the time displayed passes "12:00:00", the AM/PM setting automatically switches.
- ⚠ You cannot set the seconds. To set the time precisely, press the "MENU/OK" button when the time signal reaches zero.

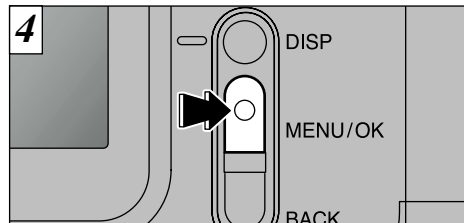

The "SET-UP" screen reappears. Press the "MENU/OK" button to complete the settings.

If the date was cleared and you selected "OK", the camera switches to still image or playback mode without returning to the "SET-UP" screen.

USING THE OPTIONAL AC POWER ADAPTER

AC power adapter (optional)

Always use a FUJIFILM AC Power Adapter AC-3V (➔P.65).

Use the AC power adapter in situations when a loss of power will cause problems, such as during file downloading (via the USB connection). Using the AC power adapter also allows you to take pictures and play back images without worrying about depleting the batteries.

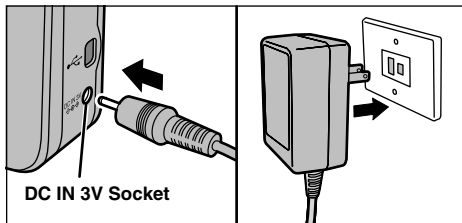

Check that the camera is switched off. Plug the AC power adapter connector into the “DC IN 3V” socket and then plug the AC power adapter into the power outlet.

- ⚠ See P.70 for notes on using the AC power adapter.
- ⚠ Only connect or disconnect the AC power adapter when the camera is switched off.
- ⚠ The socket-outlet shall be installed near the equipment and shall be easily accessible.
- ⚠ The shape of the plug and socket-outlet depends on the country of use.

Connecting the AC power adapter does not allow you to charge the Ni-MH batteries. Use the optional charger (➔P.65) to charge the Ni-MH batteries.

2 Basic Photography

STILL IMAGE MODE



TAKING PICTURES (AUTO MODE)

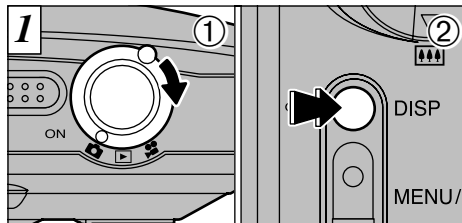



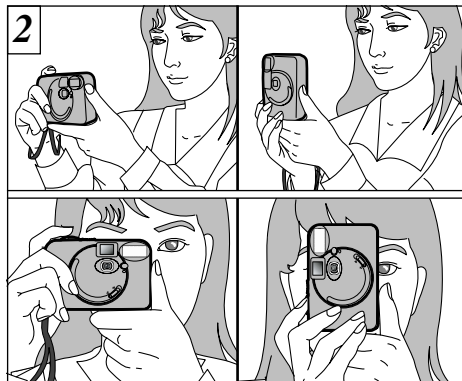

- ① Set the Mode switch to “”.
 - ② To take pictures using the LCD monitor, press the “DISP” button to switch the LCD monitor on.
- Focal range: Approx. 80 cm (2.6 ft.) to infinity



Loop the strap over your wrist, brace your elbows firmly against your body and hold the camera with both hands.

- ⚠ For close-up shots, use the Macro setting (➔P.24).
- ⚠ To minimize power consumption, use the viewfinder (switch the LCD monitor off) to take pictures.
- ⚠ The image will be blurred if the camera moves when taking the picture (camera shake). When shooting in low-light conditions, use the flash (➔P.34) or a tripod to prevent blurred images due to camera shake.

- ⚠ If a “ CARD ERROR”, “ WRITE ERROR”, “ READ ERROR” or “ CARD NOT INITIALIZED” message appears, see P.73, 74.

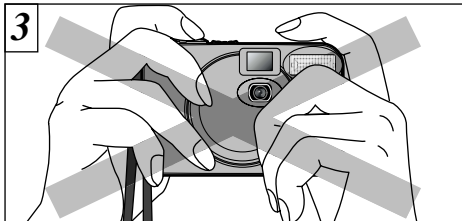

Be careful to ensure that the lens, flash and flash control sensor are not obscured by your hands or the camera strap.



Use the LCD monitor or viewfinder to locate your subject in the frame.

- ! If the lens, flash or flash control sensor is obscured by your fingers or the camera strap, you may not be able to obtain the correct brightness (exposure) for your shot.
- ! Check that the lens is clean. If it is dirty, clean the lens as described on P.67.
- ! To frame your shot precisely, you should take the picture using the LCD monitor.
- ! In some conditions it may be difficult to see your subject clearly on the LCD monitor. (Such as in sunny weather outdoors or when you are shooting dimly lit scenes.) In such situations, use the viewfinder to take the shot.

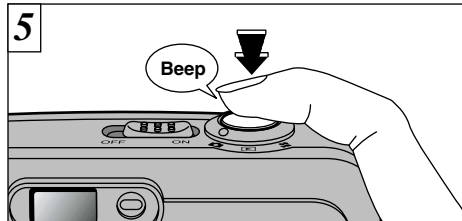

When you press the shutter button, the camera emits a short beep and takes the picture. The data is then recorded.

- ! When you press the shutter button, there is a very short delay before the picture is actually taken.
- ! The viewfinder lamp flashes orange while the flash is charging. If the LCD monitor is switched on, the screen may go dark for a moment. This is normal and does not indicate a fault.
- ! The flash charging time may increase when the battery charge getting lower.
- ! Since the amount of image data recorded is not fixed and varies depending on the subject (level of image detail, etc.), the number of available shots may not decrease after the image is recorded, or may decrease by 2.
- ! See P.73 – 74 for information on the warning displays.

Viewfinder lamp display

Color	Status	Meaning
Green	Lit	Ready to shoot
Orange	Lit	Image being recorded onto the SmartMedia.
	Flashing	Flash charging
Red	Flashing	<ul style="list-style-type: none"> ● SmartMedia warning No SmartMedia loaded, SmartMedia not formatted, incorrect format, write-protect sticker used, SmartMedia full, SmartMedia error. *When the LCD monitor is switched on, details of the warning are displayed on the monitor (→P.73 – 74).

During image recording, the viewfinder lamp glows orange and you cannot take pictures. Note also that switching the camera off or opening the battery cover during image recording could corrupt the image files.

Number of Available Shots

The number of available shots appears on the LCD monitor.

- See P.54 for information on changing the File Size and Quality settings.
- The factory default settings at shipment are 1M (File Size) and N (Quality: NORMAL).

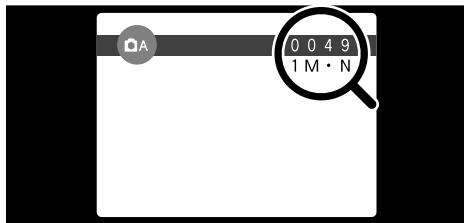

Standard number of shots per SmartMedia

The number of shots may increase or decrease slightly depending on the type of subject. Note also that the larger the SmartMedia capacity, the greater the discrepancy between the standard number of shots and the actual number of shots.

File Size	2M 1600 × 1200			1M 1280 × 960		VGA 640 × 480
	FINE	NORMAL	BASIC	FINE	NORMAL	NORMAL
Image Data Size	Approx.770KB	Approx.390KB	Approx.200KB	Approx.620KB	Approx.320KB	Approx.130KB
4MB (MG-4S)	4	9	19	6	12	30
8MB (MG-8S)	10	19	39	12	25	61
16MB (MG-16S/SW)	20	39	75	25	49	122
32MB (MG-32S/SW)	41	79	152	50	99	247
64MB (MG-64S/SW)	82	159	306	101	198	497
128MB (MG-128SW)	166	319	613	204	398	997

* The number of available shots are shown for formatted SmartMedia.

FRAMING GUIDELINE FUNCTION

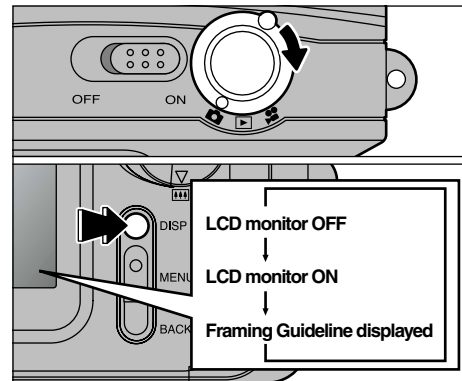

You can select the Framing Guide function in "📷" Photography mode. The mode shown on the LCD monitor switches each time you press the "DISP" button. Press the "DISP" button to display the framing guideline.

- The framing guideline is not recorded on the image.
- The lines in the scene frame roughly divide the recorded pixels into three parts horizontally and vertically. When the image is printed, the resulting print may be shifted slightly from the scene frame.

Scene

Use this frame when you want to position your main subject in the center of the frame or when you want to align your shot with the horizon. This feature provides a clear guide to the subject size and the overall balance of the shot so that you get exactly the shot you want.

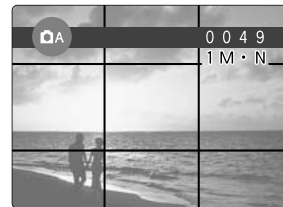

MACRO (CLOSE-UP) PHOTOGRAPHY

Selecting Macro mode allows you to take close-up shots. If the flash is set to “AUTO” or “Red-eye Reduction mode”, it is automatically set to “Suppressed Flash mode”.

● Effective Photography Range:

Approx. 8 cm to 13 cm (3.1 in to 5.1 in.).

- Using the camera width (about 10 cm or 4 in.) as a guide, ensure that the distance to the subject is between 8 cm and 13 cm (3.1 in to 5.1 in.). The camera will not focus on subjects outside this focal range.
- To use the flash, select the “Forced Flash” or “Slow Synchro” setting in the menu screen (→P.35, 36). However, you may not be able to obtain the correct brightness (exposure) for your shot.
- When shooting in dark conditions, use a tripod to prevent camera shake.

If you use the viewfinder to take a picture in Macro mode, the field visible through the viewfinder does not match the field actually photographed because the viewfinder and lens are in different positions. Accordingly, you should use the LCD monitor to take pictures in Macro mode.

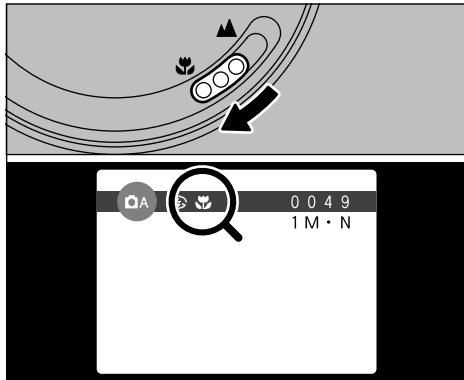

To switch to Macro mode, slide the Macro selector switch towards the Macro icon until it stops.

“🌸”: The “🌸” icon appears on the LCD monitor and you can take close-up shots.

“▲”: Macro mode is cancelled and the camera is ready for normal shooting (→P.19).

- The LCD monitor automatically switches on.
- You cannot switch the LCD monitor off.
- When you cancel Macro mode, the LCD monitor remains on.

DIGITAL ZOOM

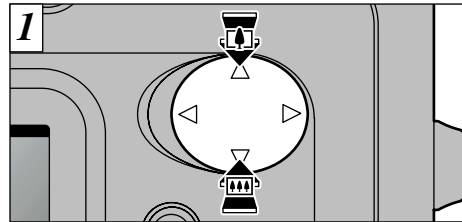

You can use the digital zoom function for only “1M” “VGA” Resolution (File Size) settings. Note that the digital zoom only functions when you use the LCD monitor to take shots. To zoom in on your subject, press “▲” (TELE). To zoom out, press “▼” (WIDE).

- You cannot use the digital zoom for resolutions of “2M”.
- See P.54 for information on changing the file size setting.

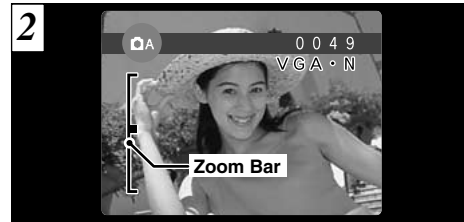

A “zoom bar” appears on the LCD monitor.

● Digital zoom focal distance (35 mm camera equivalent)

- 1M: Equivalent to approx. 36 mm – 45 mm
Max. zoom scale: 1.25x
- VGA: Equivalent to approx. 36 mm – 90 mm
Max. zoom scale: 2.5x

▶ VIEWING YOUR IMAGES (PLAYBACK)

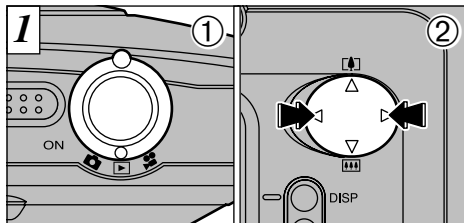

- ① Set the Mode switch to "▶".
- ② You can use "▶" and "◀" to move forward and backward respectively through your images.

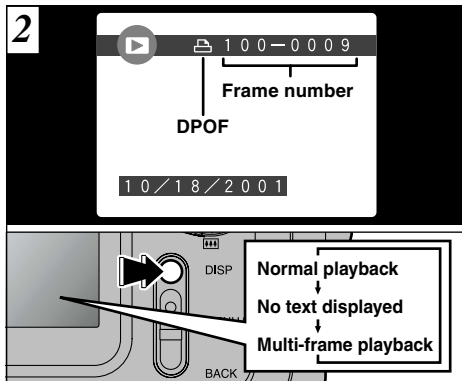

If you have specified DPOF settings, the "📁" icon is displayed. The LCD monitor display changes each time you press the "DISP" button.

- ⚠ When you set the Mode switch to "▶", the last image shot is displayed.

- ⚠ See P.53 and 55 for more information on adjusting the brightness of the LCD monitor.

◆ Images That Can be Viewed on the FinePix A201 ◆

You can use this camera to view (excluding some uncompressed data) images recorded on a FinePix A201 or images recorded onto a 3.3V SmartMedia using a FUJIFILM FinePix series, MX series or DX series digital camera.

PLAYBACK ZOOM

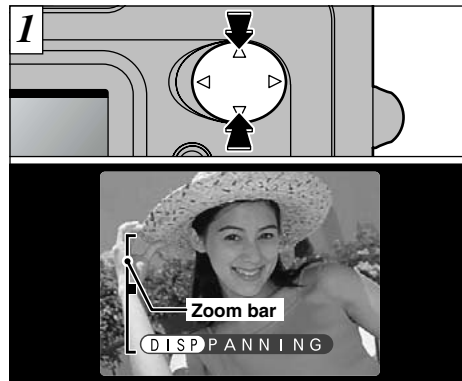

Pressing "▲" or "▼" during single-frame playback zooms in (enlarges) or out on a still image. When you use this function, a zoom bar is displayed.

● Zoom scales:

- 2M** 1600 × 1200 pixel images: Max 5×
- 1M** 1280 × 960 pixel images: Max 4×
- VGA** 640 × 480 pixel images: Max 2×

- ⚠ Pressing "◀" or "▶" during zooming cancels zooming and moves to the next image.

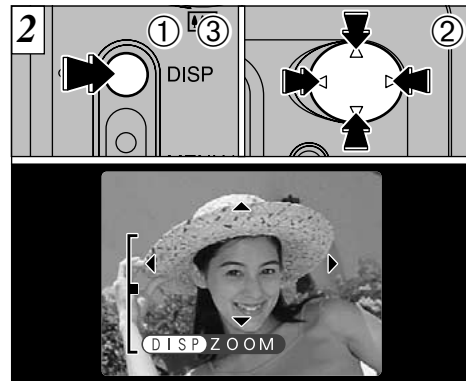

After you have zoomed in on your image,

- ① Press the "DISP" button.
 - ② Use "▲", "▼", "◀" and "▶" to zoom in on different parts of the image.
 - ③ Press the "DISP" button again to revert to zoomed display.
- ⚠ Press the "BACK" button to return to normal unscaled display.
 - ⚠ You may not be able to use playback zoom for some images shot on other camera models.

This is useful for such things as checking the focus after you take a shot.

MULTI-FRAME PLAYBACK

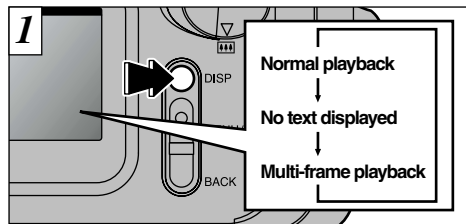

Pressing the “DISP” button during playback switches the LCD monitor to the next display mode. Press the “DISP” button several times to select multi-frame (9-frame) playback. You cannot display text during multi-frame playback.

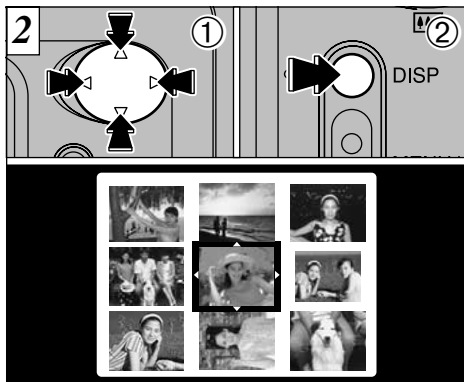

- ① Select a frame by using “◀”, “▶”, “▲” and “▼” to move the cursor (the orange box) to the desired frame. Press “▲” or “▼” several times to switch to the previous page or the next page.
- ② Press the “DISP” button to view the currently selected image at full size.

- ⚠ You cannot use multi-frame playback while a menu is displayed.
- ⚠ Playback zoom cannot be used with multi-frame playback.

ERASING SINGLE FRAME

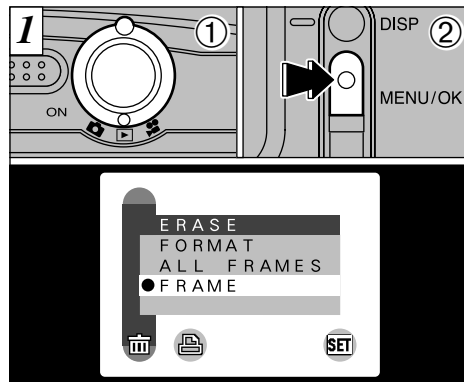

- ① Set the Mode switch to “▶”.
- ② Press the “MENU/OK” button to display the Menu screen on the LCD monitor.

- ⚠ See P.46 for more details of the “ERASE” menu.

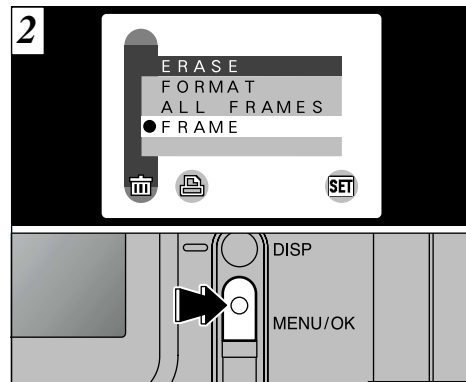

Select “FRAME” in the “ERASE” menu and press the “MENU/OK” button.

ERASING SINGLE FRAME

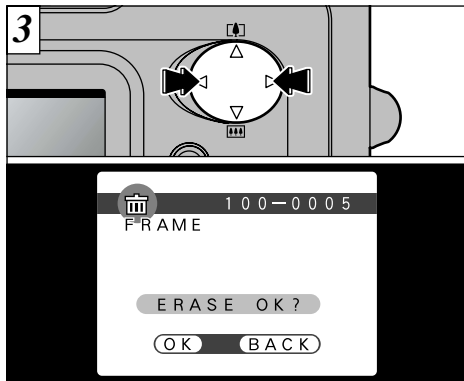

Press “◀” or “▶” to display the image to be erased.

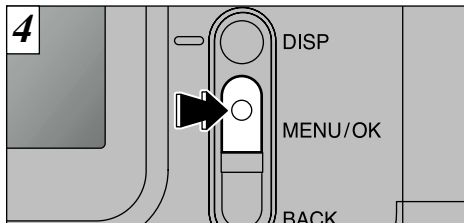

Press the “MENU/OK” button to erase the displayed image. When erasing is complete, the next image appears and the “ERASE OK?” message is displayed.

- ! “DPOF” is displayed for frames with DPOF settings and they cannot be erased (→ P.74).
- ! If the “PROTECTED FRAME” message appears, you cannot erase the frame. Use the camera on which the frame was protected to unprotect the frame.

To continue erasing images, repeat the procedure from step 3.

30 ! Press the “BACK” button to cancel frame erasing.

3 Advanced Features Photography

ADVANCED FEATURES PHOTOGRAPHY

The “Advanced Features Photography” section introduces a range of camera functions that you can access by setting the Mode switch to “” or “”.

Photography mode specifications

Mode switch	Photography mode	Accessible menu settings	Factory default	Shared menu settings
Still image	A AUTO (→P.32) This is the easiest mode for taking pictures and can be used in a wide range of conditions.	Flash (→P.34) Self-timer (→P.37)	AUTO OFF	OPTION *See P.52 for more information on each of the settings.
	M MANUAL (→P.32) This mode allows you to set the “EV” and “White balance” settings.	Flash (→P.34) EV (Exposure Compensation) (→P.39) White balance (Selecting the Light Source) (→P.40)	AUTO 0 AUTO	
Movie	Movie (→P.41) In this mode, you can shoot up to 20 seconds of video at a time.	—	—	

STILL IMAGE MODE SELECTING A AUTO OR M MANUAL

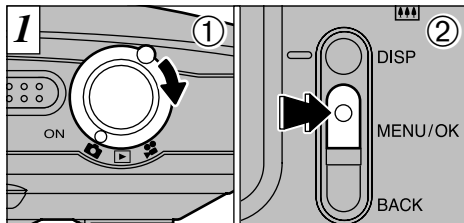

- ① Set the Mode switch to “ A”.
- ② Press the “MENU/OK” button to display the menu on the LCD monitor.

A AUTO

This is the easiest mode for taking pictures and can be used in a wide range of conditions.

M MANUAL

This mode allows you to set the “EV” and “White balance” settings.

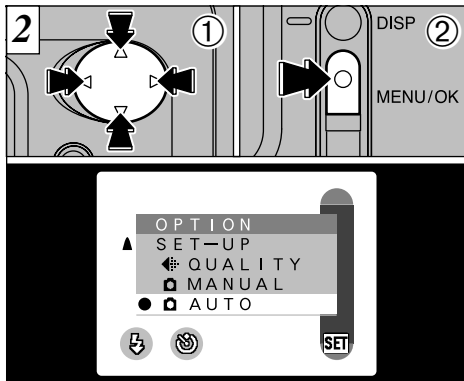

- ① Use “▲”, “▼”, “◀” and “▶” to select “ A AUTO” or “ M MANUAL” from the “ SET-UP OPTION” menu.
- ② Press the “MENU/OK” button to confirm the selection.

ⓘ See P.52 – 55 for more information on the “FILE SIZE”, “SET-UP”, “LCD BRIGHTNESS” settings.

PHOTOGRAPHY MENU PHOTOGRAPHY MENU OPERATION

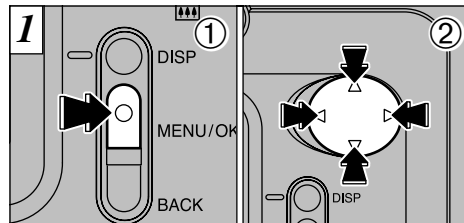

- ① Press the “MENU/OK” button to display the menu.
- ② Use “◀” and “▶” to select the menu item and “▲” and “▼” to change the setting.

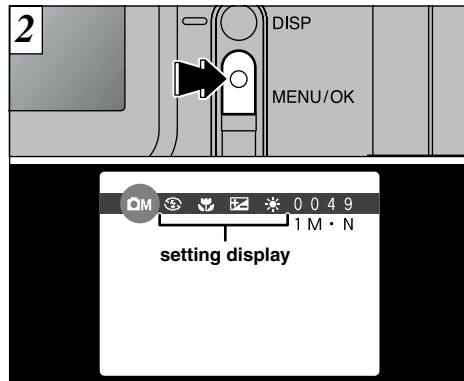

Press the “MENU/OK” button to confirm the selection.
When you validate the settings, the respective icons appear at the top of the screen.

ⓘ The settings available in the menu screen differ depending on the still image mode. See P.31 for details.

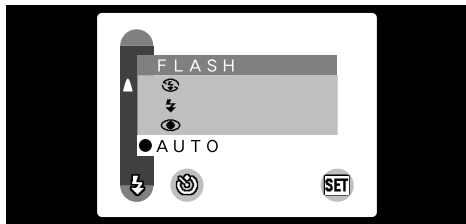

AUTO Auto Flash Mode

Use this mode for ordinary photography. The flash fires automatically as required by the shooting conditions.

⚠ You cannot use this setting in Macro (close-up) photography.

This mode can be selected in the “**DA • DM**” still image modes.

Use the flash mode that best suits your shot.

- **5 modes:** “AUTO, **👁**, **⚡**, **👁** and **S⚡**”
- **Effective flash range (in “DA AUTO” mode):**
Approx. 0.8 m to 3 m (2.6 ft. to 9.8 ft.)

- ⚠ When you select a flash mode, you may find that the displayed image disappears and the screen goes dark because the flash is charging. In this event, the viewfinder lamp flashes orange.
- ⚠ The flash charging time may increase if the charge remaining in the batteries is low.
- ⚠ If you use the flash in very dusty environments, floating dust particles may appear as glowing white dots on your image.



👁 Red-Eye Reduction

Use this mode to ensure that the subject’s eyes appear natural when photographing people in low-light conditions. The flash fires automatically as required by the photography conditions. The flash fires a pre-flash just before the picture is taken and then fires again to take the actual picture.

⚠ You cannot use this setting in Macro (close-up) photography.

◆ **Red-Eye Effect** ◆

When you use the flash to photograph people in low-light conditions, their eyes sometimes appear red in the picture. This is caused by the light of the flash reflecting off the inside of the eye. Use Red-Eye Reduction flash to effectively minimize the likelihood of the red-eye effect.

Take the following measures also to make Red-Eye Reduction more effective :

- Get the subjects to look at the camera.
- Get as close as possible to the subjects.



⚡ Forced Flash

Use this mode to photograph backlit scenes, such as a subject against a window or in the shade of a tree, or to obtain the correct colors when you are shooting under lighting such as fluorescent tubes. In this mode, the flash fires in bright as well as dark conditions.



⚡ Suppressed Flash

Use this mode for photography using indoor lighting, for shots taken through glass, and for photography in venues such as theaters or at indoor sporting events where the distance is too great for the flash to be effective. When you use Suppressed Flash, the Automatic White Balance function (➡P.80) operates so that natural colors are captured along with the ambience of the available light.

- ⚠ If you are shooting in Suppressed Flash mode in dark conditions, use a tripod to prevent camera shake.
- ⚠ See P.74 for information on the camera shake warning.



⚡ S Slow Synchro

This is a flash mode that uses a slow shutter speed. This allows you to take pictures of people at night that clearly show both your subjects and the night time backdrop.

- ⚠ The image may be overexposed when you shoot bright scenes.
- ⚠ Because a slow shutter speed is used, a tripod should be used to prevent camera shake.

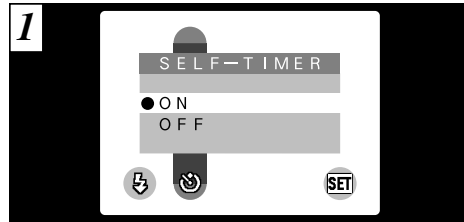

This mode can be selected in the “**QA**” still image mode. In this mode, a timer runs for roughly 10 seconds before the shutter is released. Use this mode for shots such as photographs of yourself.

- ⚠ The self-timer is automatically cancelled in the following situations:
 - When you take a picture.
 - When you switch from the “**QA**” photography mode to another mode.
 - When the camera is switched off.

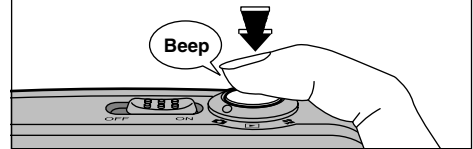
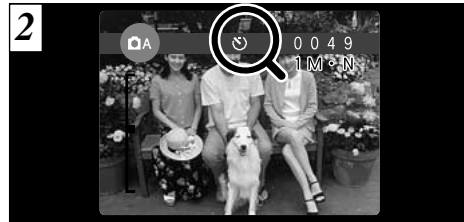

Locate the subject in the LCD monitor or viewfinder and frame the shot. Then press the shutter button to trigger the self-timer.

- ⚠ Do not stand in front of the camera when you press the shutter button as this will result in an incorrect brightness (exposure) setting for the shot.

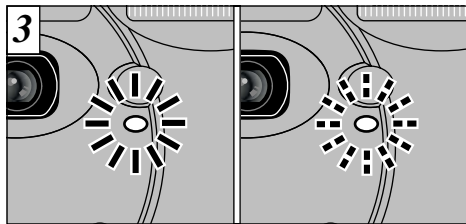

The self-timer lamp lights steadily for approximately 5 seconds, blinks for another approximately 5 seconds and then takes the shot.

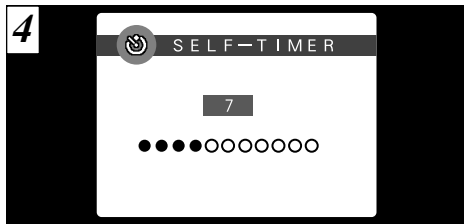

The LCD monitor counts down the time until the shot is taken. Self-timer mode is automatically cancelled after each shot.

To stop the self-timer once it has started running, press the "BACK" button.

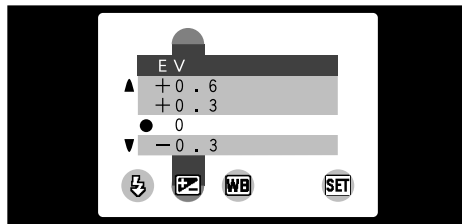

This mode can be selected in the "Q" still image mode.

Use the Brightness setting to obtain the optimum image brightness (exposure) when the subject is much brighter or darker than the background.

- **Correction range:** 11 steps
(-1.5 EV to +1.5 EV in 0.3 EV increments)
See P.80 for information on EV.

- ⚠ The Brightness setting is disabled in the following situations:
 - When the flash is used in Auto or Red-Eye Reduction mode.
 - When dark scenes are shot in Forced Flash mode.

◆ Subjects for Which Exposure Adjustment is Particularly Effective ◆

Guide to using + (positive) compensation

- Copying of printed text (black characters on white paper) (+1.5 EV)
- Backlit portraits (+0.6 EV to +1.5 EV)
- Very bright scenes (such as snowfields) and highly reflective subjects (+0.9 EV)
- Shots made up predominantly of sky (+0.9 EV)

Guide to using - (negative) compensation

- Spotlit subjects, particularly against dark backgrounds (-0.6 EV)
- Copying of printed text (white characters on black paper) (-0.6 EV)
- Scenes with low reflectivity, such as shots of pine trees or dark foliage (-0.6 EV)

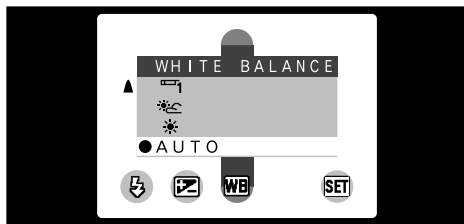

This mode can be selected in the “OM” still image mode.

In Auto mode, the correct white balance may not be obtained for subjects such as close-ups of people’s faces and shots taken under a special light source.

Change the white balance setting when you want to take a picture with the correct balance. See P.80 for more information on the white balance.

AUTO: Automatic adjustment
(Shooting to show the ambience of the light source)

- : Shooting outdoors in fine weather
- : Shooting in shade
- : Shooting under “Daylight” fluorescent lamps
- : Shooting under “Warm White” fluorescent lamps
- : Shooting under “Cool White” fluorescent lamps
- : Shooting in incandescent light

* The white balance setting is ignored when the flash is used. To achieve the desired effect in your shot, set the flash to Suppressed Flash mode (➡P.36).

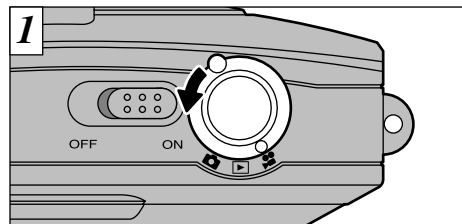

Set the Mode switch to “”.

Movie

This mode allows you to shoot up to 20 seconds of movie at a time.

- **Movie format:** Motion JPEG (➡P.80)
320 × 240 pixels
10 frames per second
Without sound

- ⚠ Select Macro mode for close-up shots (➡P.24).
- ⚠ The shooting time per shot may be shorter than 20 seconds depending on the available space on the SmartMedia.
- ⚠ You cannot switch the LCD monitor off in this mode.
- ⚠ In some cases, playback may not be possible on other camera models.

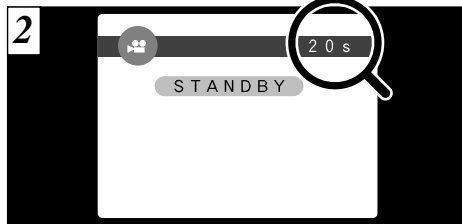

The available shooting time and the “STANDBY” message are shown on the LCD monitor.

■ SmartMedia standard shooting time

SmartMedia capacity	Available shooting time
MG-4S (4MB)	Approx. 23 sec.
MG-8S (8MB)	Approx. 47 sec.
MG-16S/SW (16MB)	Approx. 94 sec.
MG-32S/SW (32MB)	Approx. 191 sec.
MG-64S/SW (64MB)	Approx. 385 sec.
MG-128SW (128MB)	Approx. 774 sec.

* These movie shooting times are for newly formatted SmartMedia.

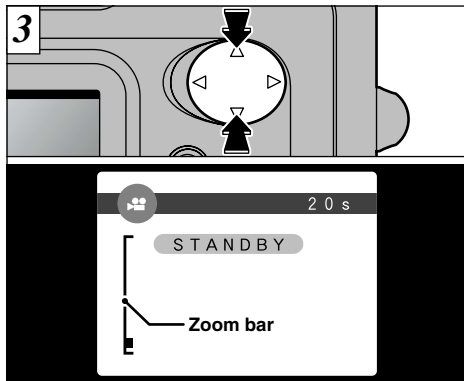

You can use “▲” and “▼” to zoom in and out. A “zoom bar” is displayed on the LCD monitor.

● **Digital zoom focal distance (35 mm camera equivalent)**

Approx. 36 mm to 90 mm
Max. zoom scale: 2.5×

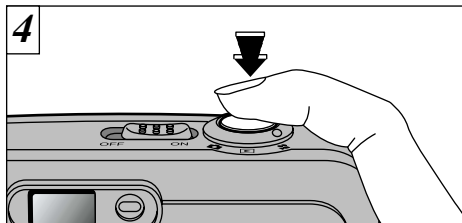

When you press the shutter button, the camera starts shooting.

- ! When you press the shutter button, there is a very brief delay before the camera starts shooting.
- ! You do not need to hold down the shutter button.
- ! The white balance is fixed during shooting, but the exposure varies automatically to suit the scene being shot.

The white balance is set automatically when you press the shutter button.

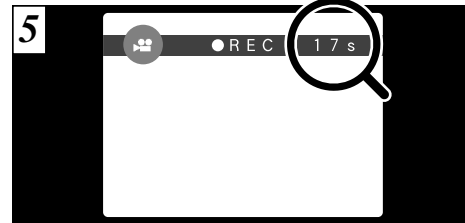

During shooting, “●REC” appears on the LCD monitor with a counter showing the remaining time displayed in the top-right corner.

- ! Once the remaining time runs out, movie recording automatically stops and the movie is stored on the SmartMedia.

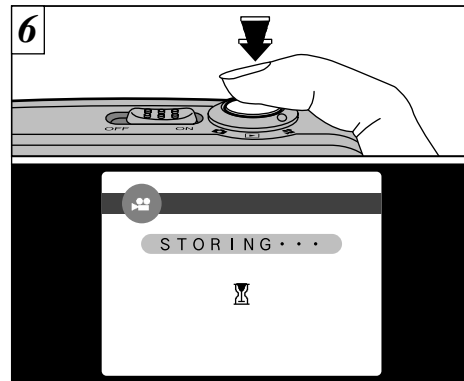

If you press the shutter button during shooting, shooting ends and the movie is stored on the SmartMedia.

- ! The time required to record a 20 seconds movie (roughly 3 MB) is approximately 3 seconds.
- ! If you end shooting immediately after you start shooting, only 3 seconds of movie is shot.

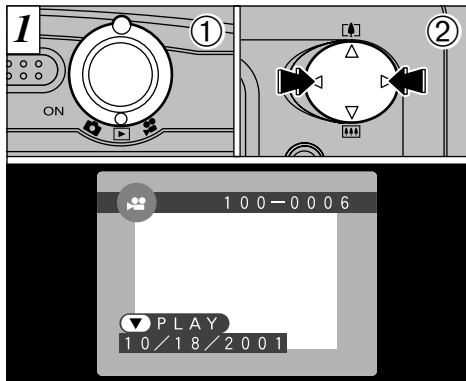

- ① Set the Mode switch to “”.
- ② Use “” or “” to select the movie file.

⚠ Movies cannot be played back using multi-frame playback. Use the “DISP” button to revert to normal playback.

Movies are displayed somewhat smaller than still images.

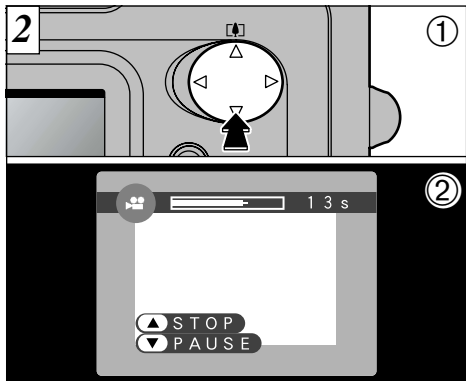

- ① Press “” to play the movie.
- ② The LCD monitor shows the playback time and a playback progress bar.

⚠ If the subject of the movie is very bright, white streaks may appear on the image during playback. This is normal and is not a fault.

■ Playing back movies



	Control	Description
Playback		The movie automatically stops when playback ends.
Pause/Resume		Pauses the movie during playback. Press this button again to resume playback.
Stop		Stops playback. * Press “” or “” while movie playback is stopped to go back to the previous file or advance to the next file respectively.
Fast forward/Rewind	 Rewind Forward	Press these during playback to skip forwards or backwards through the movie.
Skip playback	 When paused	<ul style="list-style-type: none"> • Each time you press “” or “” when the movie is paused, the movie advances or goes back one frame. • Hold down the button to move through the frames quickly.

◆ Compatible movie files ◆

The FinePix A201 can play back movie files shot on a FinePix A201 and movie files up to 20 seconds long that were shot on a FUJIFILM digital camera and stored on a 3.3V SmartMedia. However, this camera cannot play back sound. If you attempt to play back a movie that is longer than 20 seconds, the “ READ ERROR” message appears and playback fails.

FRAME

Erase only the selected file.

- ⚠ The file for which “ PROTECTED FRAME” was displayed cannot be erased. Unprotect the frame using the camera on which the protection was first applied.
- ⚠ “ DPOF” is displayed for frames with DPOF settings and they cannot be erased (➔ P.74).





ALL FRAMES

All files are erased except those that are protected or that have DPOF settings. Copy any files that you want to keep to your PC beforehand.

FORMAT

Formatting erases all the files. Take particular care when formatting a SmartMedia as this procedure also erases all protected files and all files with DPOF settings. Copy any files that you want to keep to your PC beforehand.

- ⚠ Formatting also erases protected files.

- ⚠ If a “ CARD ERROR”, “ WRITE ERROR”, “ READ ERROR” or “ CARD NOT INITIALIZED” message appears, see P.73, 74.

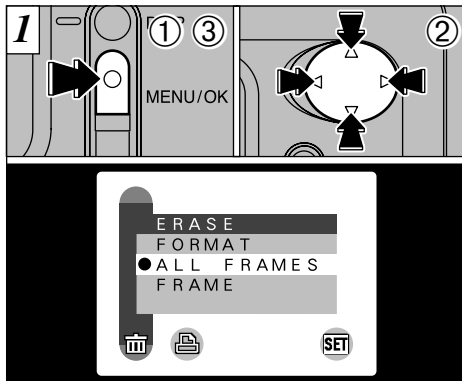

- ① Press the “MENU/OK” button to display the menu.
 - ② Use “◀” or “▶” to select “ ERASE” and then use “▲” or “▼” to select “FRAME”, “ALL FRAMES” or “FORMAT”.
 - ③ Press the “MENU/OK” button.
- ⚠ Press the “BACK” button to exit the menu.

Formatting erases all the data on the SmartMedia, including protected files.

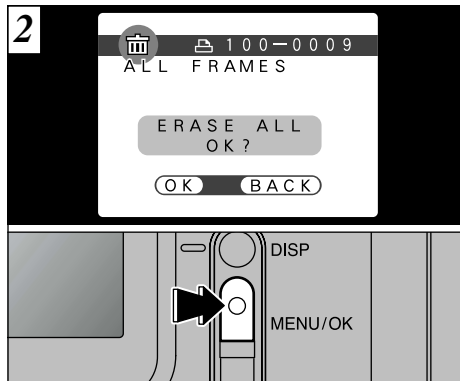

A confirmation message appears. In “FRAME” mode, use “◀” or “▶” to select the file and then press the “MENU/OK” button. When using “ALL FRAMES” or “FORMAT”, press the “MENU/OK” button.

- ⚠ To cancel the frame erase procedure, press the “BACK” button.



DPOF stands for Digital Print Order Format and refers to a format that is used for recording printing specifications for images shot using a digital camera on media such as SmartMedia. The recorded specifications include information on which frames are to be printed.

This section gives a detailed description of how to order your prints with the FinePix A201. On the FinePix A201, you can specify only one print per image in the DPOF settings.

- * Note that some printers do not support date and time imprinting or specification of the number of prints.
- * Note that the warnings shown below may be displayed while you are specifying the prints.

! DPOF (⇒P.74)

If the “! DPOF” message appears, you cannot erase the frame. Cancel the “DPOF” settings and then try again

! DPOF FILE ERROR (⇒P.74)

No more than 1000 frames can be specified on the same SmartMedia.

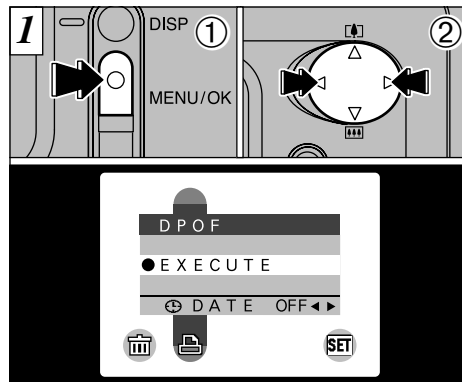

This function allows you to select whether or not the date of shooting is included on the print.

- ① Press the “MENU/OK” button to display the menu on the LCD monitor.
- ② Use “◀” or “▶” to select “DPOF”.

- ! The DPOF menu options do not appear when a movie file is selected.
- ! You may not be able to specify DPOF settings for some still shots taken on other cameras.

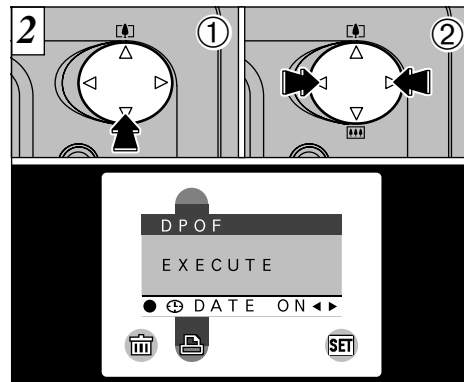

- ① Use “▼” to select “DATE”.
- ② Use “◀” or “▶” to specify “DATE ON” or “DATE OFF”. The selected setting is then valid for all frames with DPOF settings until the camera is switched off. Then specify the DPOF settings (⇒P.50).

- ! You must specify whether or not the date is included before you specify the DPOF settings.

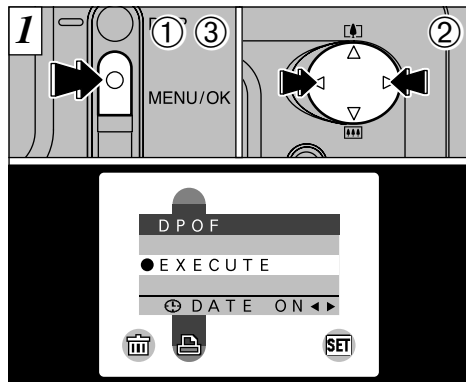

You can only specify one print per frame (image) in the DPOF settings.

- ① Press the "MENU/OK" button to display the menu.
- ② Use "◀" or "▶" to select "DPOF".
- ③ With "OK" selected, press the "MENU/OK" button.
- ⚠ The DPOF menu options do not appear when a movie file is selected.
- ⚠ You cannot specify printing for more than one print per frame.

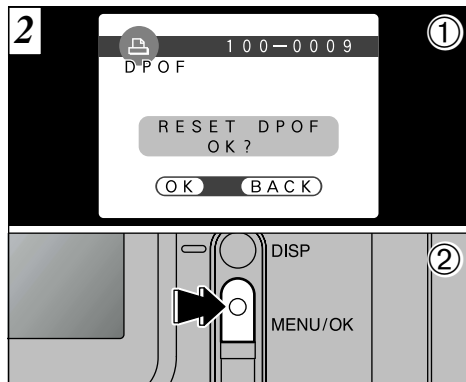

- ① If you select a frame for which DPOF settings have already been specified, the "RESET DPOF OK?" message appears.
- ② **Pressing the "MENU/OK" button erases all the DPOF settings already specified. You must then specify the DPOF settings again.**
- ⚠ Press the "BACK" button to leave the previous settings unchanged.
- ⚠ You can check the previous settings by playing back the images (→P.26).

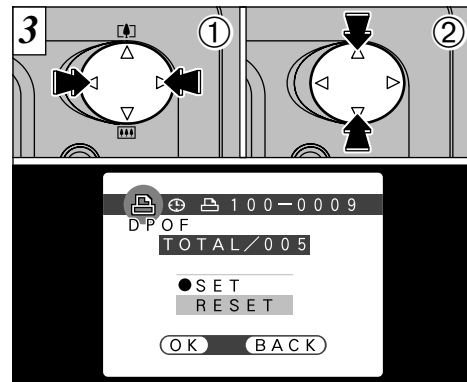

- ① Use "◀" or "▶" to display the frame for which you want to specify DPOF settings.
- ② Use "▲" or "▼" to select the setting for the frame to be printed. If you have selected the date setting, the "⌚" icon is displayed.
- ⚠ DPOF settings cannot be specified for movies.
- ⚠ Note that the "⌚" icon is not displayed during playback.
- ⚠ "TOTAL" shows the total number of frames for which prints have been ordered.

To specify more DPOF settings, repeat steps ① and ②.

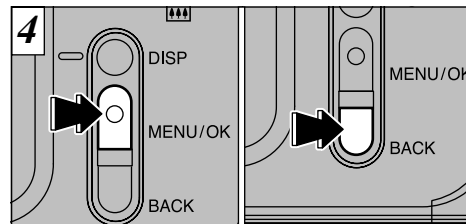

When you have finished specifying the DPOF settings, always press the "MENU/OK" button to confirm the settings. If you press the "BACK" button, no DPOF settings are specified.

- ⚠ You can only specify one print per frame in the DPOF settings. Note also that you can specify prints for up to 999 frames on the same SmartMedia.

Pressing the "MENU/OK" button confirms all the settings. You cannot reset a portion of the settings without resetting them all.

The “Settings” chapter looks at functions available from “ OPTION” in the “” still Image, “” movie and “” playback.

List of settings

Still Image mode	Movie mode	Playback mode
AUTO	—	—
MANUAL	—	—
FILE SIZE (P.54)	—	—
SET-UP	SET-UP	SET-UP
LCD BRIGHTNESS (P.55)	LCD BRIGHTNESS (P.55)	LCD BRIGHTNESS (P.55)

SET-UP menu options

Settings	Display	Factory default	Explanation
POWER SAVE	ON/OFF	ON	This is a function that reduces power consumption and then automatically switches the camera off to prevent battery depletion when the camera is not being used. See P.56 for details.
USB MODE	DSC/PC CAM	DSC	See P.57 for details.
DATE/TIME	SET	—	You can use this to set the date and time. See P.16 for details.
BEEP	LOW/HIGH/OFF	LOW	This setting selects the volume of the beep emitted by the camera during camera operation.
LANGUAGE	ENGLISH/FRANCAIS	ENGLISH	Select English or French as the language used for screen display.

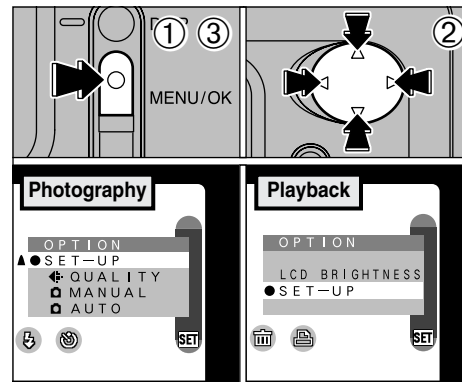

- Press the “MENU/OK” button to display the menu screen.
- Use “” or “” to select “ OPTION” and “” or “” to select the desired setting.
- Press the “MENU/OK” button to move to the selected setting.

Using SET-UP

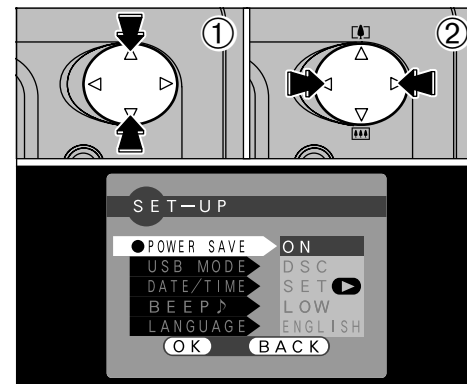



If you selected “SET-UP”, the “SET-UP” screen appears.

- Use “” or “” to select the desired setting.
- Use “” or “” to change the setting.
Press the “MENU/OK” button to exit set-up.

For “DATE/TIME” press “”.

SET SETTING THE FILE SIZE AND QUALITY (COMPRESSION RATIO)

You can choose any combination of 3 file sizes and 3 image quality settings. Use the table below as a guide to the best settings for your shots.

File size	FINE	NORMAL	BASIC
 2M (1600 × 1200)	①	①	②
 1M (1280 × 960)	②	②	—
 VGA (640 × 480)	—	③	—

- ①: For printing the whole image at A5 size or printing a part of the image at A6 size
- ②: For printing at A6 size
- ③: For use via the Internet as an e-mail attachment, etc.

Quality (compression ratio)

Select “FINE” for better image quality and “BASIC” to increase the number of available shots.

In most cases, the “NORMAL” setting provides more than adequate image quality.

 The number of available shots varies depending on the combination of file size and quality settings you select (→P.22).

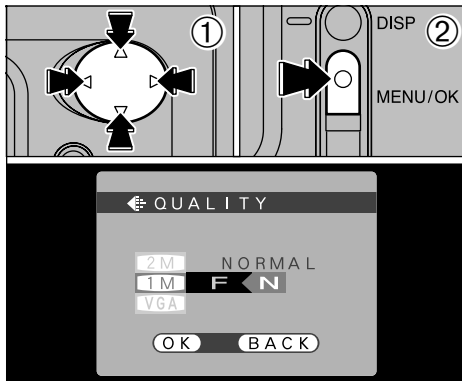

- ① Use “▲” or “▼” to change the file size setting and “◀” or “▶” to change the quality setting.
- ② Press the “MENU/OK” button to confirm the setting.

 To exit this procedure without changing the settings, press the “BACK” button.

SET LCD MONITOR BRIGHTNESS

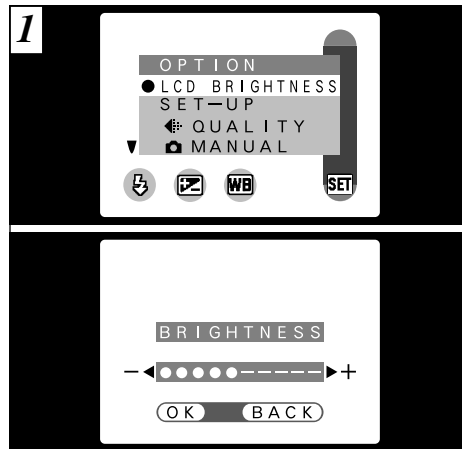

When you use the “LCD BRIGHTNESS” settings, an “adjustment bar” appears on the LCD monitor.

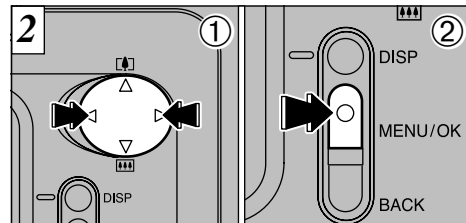

- ① Use “◀” or “▶” to adjust the LCD monitor brightness.
- ② Press the “MENU/OK” button to confirm the adjustment.

 To exit this procedure without changing the settings, press the “BACK” button.

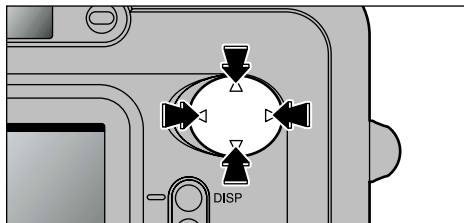
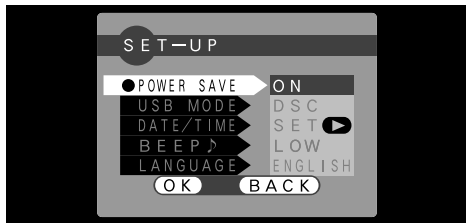

●**Power saving “ON”** (default setting)
Power consumption is kept to a minimum to prevent battery depletion. You should select the “ON” setting when you are using alkaline batteries.

- If the camera is not used for approximately 30 seconds, the LCD switches off temporarily to reduce power consumption (Sleep mode).
- Once the camera is in Sleep mode, if it is left unused for a further 90 seconds, it is automatically switched off.
- The charging time for the flash increases slightly because the flash charging power is reduced.

To bring the camera out of sleep mode so that it is ready to shoot, press “◀”, “▶”, “▲” or “▼”. This is useful since the camera is ready to shoot more quickly than when it is switched off and then on again. You can also take pictures when the camera is in sleep mode simply by pressing the shutter button.

- ⚠ Power Save/Auto Power Off does not function when a USB connection is being used.
- ⚠ You can also bring the camera out of sleep mode by pressing buttons other than “◀”, “▶”, “▲” or “▼”.

The Sleep function does not operate when the LCD monitor is switched off, while you are setting the file size or when the camera is in SET-UP or Playback mode. However, if the camera controls are not used for 2 minutes, the camera automatically switches off.

PC Connection describes how to set up a USB connection and provides an overview of the functions available using a USB connection. Refer also to the Software Quick Start Guide booklet.

DSC (Mass storage device) Mode

This mode provides a simple way to read images from a SmartMedia and store images on to a SmartMedia (➔P.58).

PC-CAM (camera) Mode

This function allows you to conduct videoconferencing sessions between PCs connected to the Internet. This function can also be used to record video on a PC (➔P.60).

⚠ **Videoconferencing is not available for Macintosh computers.**

◆ **The First Time You Connect Your Camera to a Computer** ◆

You must set up your computer as described below. Refer also to the Software Quick Start Guide booklet.

Windows

- ① Load the enclosed CD-ROM into your PC's CD-ROM drive and install the application software.
- ② With the CD-ROM loaded into your PC, select DSC connection mode and install the driver software.
- ③ With the CD-ROM loaded into your PC, select PC CAMERA connection mode and install the driver software.

Macintosh

Load the enclosed CD-ROM into the CD-ROM drive and install all the software.

CONNECTING AT DSC (MASS STORAGE DEVICE) MODE

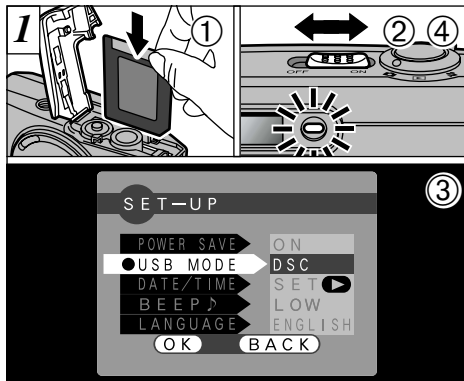

- 1 Load a SmartMedia containing images into your camera.
- 2 Slide the Power switch sideways to switch the camera on.
- 3 Set the "USB MODE" setting in the "SET-UP" menu to "DSC" (→P.52, 53).
- 4 Slide the Power switch sideways to switch the camera off.

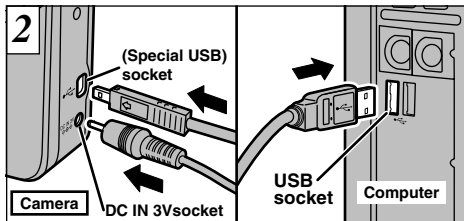

- 1 Switch your computer on.
- 2 Use the special USB cable to connect the camera to your computer.
- 3 Switch the camera on.

If you are connecting your camera to a Windows PC for the first time, the "Add New Hardware Wizard" window opens and driver software installation begins (→Software Quick Start Guide booklet).

Always use the prescribed procedure when disconnecting or switching off the camera (→P.62).

- ⚠ You should use the optional AC power adapter when the camera is connected to your computer (→P.18, 65). Loss of power during data transmission can prevent successful data downloading (It also preserves battery power).
- ⚠ Ensure that you insert the USB cable plugs into the correct sockets.
- ⚠ Push the cable plugs firmly into the connector sockets.

Camera Operation

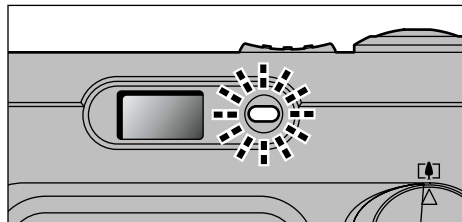

- The viewfinder lamp alternately blinks green and orange while the camera is communicating with your computer.
- "DSC" appears on the LCD monitor.
- Power Save/Auto Power Off does not function when a USB connection is being used.

- ⚠ Switch the camera off when you change the SmartMedia (→P.62).
- ⚠ Do not disconnect the USB cable when the camera is communicating with the computer. See P.62 for information on the disconnection procedure.

Computer Operation

- FinePixViewer automatically starts up.



*Screen for Windows 98 SE

- A removable disk icon appears and you can use your computer to transfer files to and from the camera.

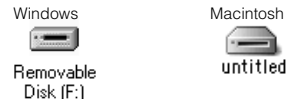

If the above operations do not occur, you do not have the required software programs or drivers installed on your computer. Refer to the Software Quick Start Guide booklet and complete the required computer setup procedures. Then reconnect the camera to your computer.

CONNECTING AT PC-CAMERA MODE

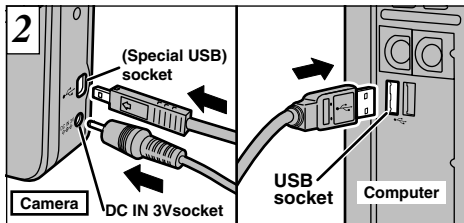
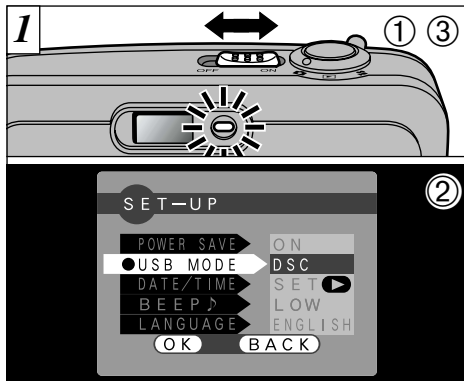

- 1 Switch your computer on.
- 2 Use the special USB cable to connect the camera to your computer.
- 3 Switch the camera on.

If you are connecting your camera to a Windows PC for the first time, the "Add New Hardware Wizard" window opens and driver software installation begins (⇒Software Quick Start Guide booklet).

Always use the prescribed procedure when disconnecting or switching off the camera (⇒P.62).

- ⚠ You should use the optional AC power adapter when the camera is connected to your computer (⇒P.18, 65). Loss of power during data transmission can prevent successful data downloading (It also preserves battery power).
- ⚠ Ensure that you insert the USB cable plugs into the correct sockets.
- ⚠ Push the cable plugs firmly into the connector sockets.

- 1 Slide the Power switch sideways to switch the camera on.
 - 2 Set the "USB MODE" setting in the "SET-UP" menu to "PC CAM" (⇒P.52, 53).
 - 3 Slide the Power switch sideways to switch the camera off.
- ⚠ Select Macro mode for close-up shots (⇒P.24). Although the "📷" icon is not displayed.

Camera Operation

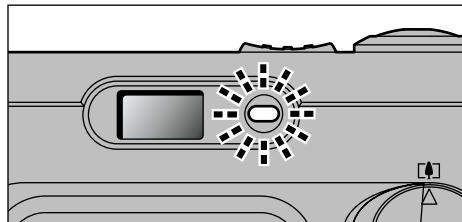

- The viewfinder lamp alternately blinks green and orange while the camera is communicating with your computer.
- "PC CAMERA" appears on the LCD monitor.
- Power Save/Auto Power Off does not function when a USB connection is being used.

- ⚠ Do not disconnect the USB cable when the camera is communicating with the computer. See P.62 for information on the disconnection procedure.

Computer Operation

- FinePixViewer automatically starts up and the Picture Hello window opens (Windows only).



* Screen for Windows 98 SE

- You can use software such as VideoImpression to view live images.



* Macintosh screen

If the above operations do not occur, you do not have the required software programs or drivers installed on your computer. Refer to the Software Quick Start Guide booklet and complete the required computer setup procedures. Then reconnect the camera to your computer.

DISCONNECTING FROM THE PC (Important — always use this procedure.)

Always follow the procedure below before disconnecting the camera from your PC.

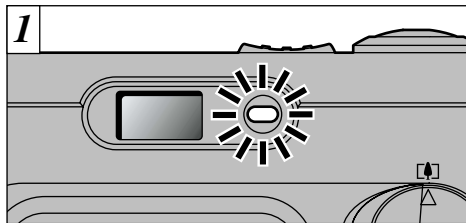

- 1 Quit all applications (FinePixViewer, VideoImpression, etc.) that are using the camera.
- 2 Check that the viewfinder lamp is glowing green (that the camera is not communicating with the computer).

For a PC CAMERA connection, proceed to step 3.

- Even after the “Copying...” message is no longer displayed on your computer, communication with the camera may still be in progress. Always check that the viewfinder lamp on the camera is glowing green and is no longer flashing.

- 2 Perform the steps shown below before you switch the camera off. This procedure differs depending on the operating system software (or PC) you are using.

Windows 98 or 98 SE

No PC operation is needed.

Windows Me

Left-click the Eject icon in the taskbar and eject “USB disk”.



* Display this message and then click the “OK” button.

Windows 2000 Professional

Left-click the Eject icon in the taskbar and eject “USB Mass Storage”.

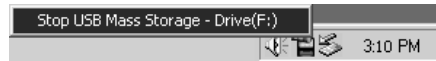

* Display this message and then click the “OK” button.

Macintosh

Drag the “Removable drive” icon on the desktop to the Trash.

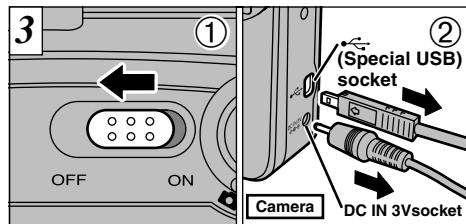

- 1 Switch the camera off.
- 2 Unplug the special USB cable from the camera.

- If you are using Windows, you cannot disconnect the camera by right-clicking the removable disk icon (the camera) and selecting “Eject”. Always follow the proper procedure as given above before disconnecting the camera from your PC.

System Expansion Options

- By using the FinePix A201 together with other optional FUJIFILM products, your system can be expanded to fill a wide range of uses.

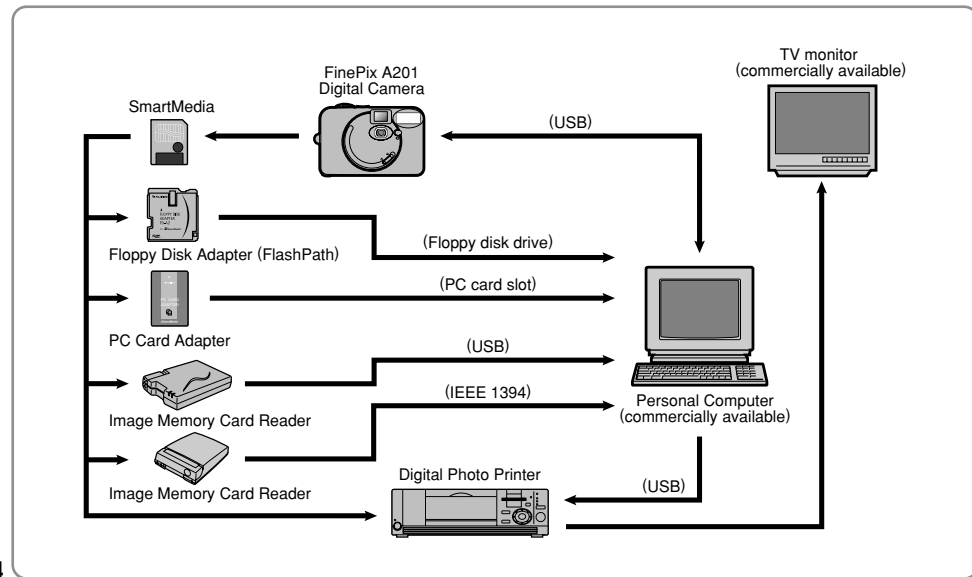

Accessories Guide

- The optional accessories (sold separately) can make taking pictures with the FinePix A201 even easier. For information on how to attach and use the accessories, refer to the instructions provided with the accessory used.

● SmartMedia™

These are separately available SmartMedia cards.

Use the following SmartMedia:

- MG-4S: 4MB, 3.3V
 - MG-8S: 8MB, 3.3V
 - MG-16S/SW: 16MB, 3.3V
 - MG-32S/SW: 32MB, 3.3V
 - MG-64S/SW: 64MB, 3.3V
 - MG-128SW: 128MB, 3.3V
- * Some 3.3V SmartMedia are labelled as "3V" or "ID" cards.

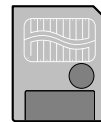

● AC Power Adapter AC-3V

Use the AC power adapter when you want to take pictures or play back images for long periods or when the camera is connected to a computer.

* The shape of the AC power adapter, the plug and socket outlet depend on the country.

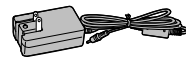

● Fujifilm Rechargeable Battery 2HR-3UF

The 2HR-3UF includes 2 pieces of high-capacity AA-size Nickel Metal Hydride batteries.

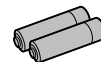

● Fujifilm Battery charger with Battery BK-NH (With Euro type or UK type plug)

The BK-NH includes the quick battery charger BCH-NH and 2 Ni-MH batteries.

The BCH-NH can charge 2 Ni-MH batteries in approximately 120 minutes.

Up to 4 Ni-MH batteries can be charged simultaneously.

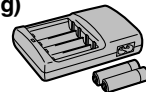

● SC-FXA01

This is a special case made of polyester that protects the camera against soiling, dust and minor impacts when it is being carried.

● **FD-A2 Floppy Disk Adapter (FlashPath)**

This adapter is the same size and shape as a 3.5-inch floppy disk. You can copy the images on a SmartMedia to your PC simply by loading the SmartMedia into the floppy disk adapter and then inserting the adapter into your floppy disk drive.



	Compatible OS	Compatible SmartMedia
FD-A2	Windows 95/98/98SE/Me/NT4.0 Mac OS 7.6.1 to 9.1	5V/3.3V, 2MB to 128MB

● **SM-R2 Image Memory Card Reader**

The SM-R2 provides a quick and easy way to transfer images back and forth between your PC and an image memory card (SmartMedia). The SM-R2 uses the USB interface for high-speed file transfer.

- Compatible with Windows 98/98SE, Windows Me, Windows 2000 Professional or iMac and models that support USB as standard.

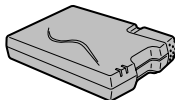

● **DM-R1 Image Memory Card Reader**

This device provides a simple way to transfer image data in either direction between your PC and an image memory card (SmartMedia or CompactFlash Type II (Microdrive-compatible)).

The IEEE 1394 interface provides high-speed data transfer.

- Compatible with Windows 98SE, Windows 2000 Professional (read-only), iMacDV and Power Macintosh PCs with FireWire as a standard feature. Mac OS 8.5.1 to 9.0



● **PC-AD3 PC Card Adapter**

The PC Card Adapter allows the SmartMedia to be used as a PC Card Standard ATA-compliant (PCMCIA 2.1) PC card (Type II).

- Compatible with SmartMedia of 5V/3.3V, 2MB to 128MB.



► Be sure to read this information in conjunction with “Safety Notes” (→P.81), to ensure that you use your camera correctly.

■ **Places to Avoid**

Do not store or use the camera in the following types of locations:

- Very humid, dirty or dusty places
- In direct sunlight or in places subject to extreme temperature rises, such as in a closed car in summer.
- Extremely cold places
- Places subject to strong vibration
- Places affected by smoke or steam
- Places subject to strong magnetic fields (such as near motors, transformers or magnets)
- In contact with chemicals such as pesticides or next to rubber or vinyl products for long periods of time

■ **Do not expose the camera to sand.**

The FinePix A201 is particularly and adversely affected by sand. In sandy locations such as beaches or deserts, or in locations where there is wind borne sand, ensure that the camera is not exposed to sand. This can cause faults that may be irreparable.

■ **Notes on Condensation**

If the camera is carried suddenly from a cold location into a warm place, water droplets (condensation) may form on the inside of the camera or on the lens. When this occurs, switch the camera off and wait an hour before using the camera. Condensation may also form on the SmartMedia

card. In this event, remove the SmartMedia and wait a short time before using it again.

■ **When the Camera is Unused for Long Periods**

If you do not intend to use the camera for a long period, of time remove the batteries and the SmartMedia card before storing the camera.

■ **Cleaning Your Camera**

- Use a blower brush to remove dust from the lens, LCD monitor screen or viewfinder as these surfaces, and then wipe lightly with a soft, dry cloth. If any soiling remains, apply a small amount of lens cleaning liquid to a piece of FUJIFILM lens cleaning paper and wipe gently.
- Do not scratch hard objects against the lens, LCD monitor screen or viewfinder as these surfaces are easily damaged.
- Clean the body of the camera with a soft, dry cloth. Do not use volatile substances such as thinners, benzene or insecticide, as these may react with camera body and cause deformation or remove the coating.

■ **Using the Camera Overseas**

When travelling overseas, do not place your camera in the check-in baggage. Baggage handling at airports may subject baggage to violent shocks, and the camera may be damaged internally even when no external damage is visible.

Notes on the Power Supply

Applicable Batteries

- AA-size alkaline, Ni-MH (nickel metal hydride) can be used with this camera.
Do not use AA-size manganese, lithium batteries in your FinePix A201 because the heat generated by the batteries could damage the camera or cause malfunctions.
- The operating lives of alkaline batteries vary between brands and the life of batteries you purchase may be shorter than the alkaline batteries provided with the camera.

Notes on the Batteries

Incorrect use of the batteries could cause them to leak, become hot, ignite or burst. Always observe the precautions given below.

- Do not heat the batteries or throw them into a fire.
- Do not carry or store a battery with metal objects such as necklaces or hairpins that could come into contact with the metal positive ⊕ and negative ⊖ poles of the battery.
- Do not expose the batteries to fresh or sea water, and take particular care to keep the terminals dry.
- Do not attempt to deform, disassemble or modify the batteries.
- Do not attempt to peel off or cut the battery casing.
- Do not drop, strike or otherwise subject the batteries to strong impacts.

- Do not use batteries that are leaking, deformed, discolored or exhibit any other obvious abnormality.
- Do not store batteries in very warm or moist locations.
- Keep the batteries out of reach of babies and small children.
- When loading the batteries into the camera, ensure that the battery polarity (⊕ and ⊖) is as indicated on the camera.
- Do not use new batteries together with used batteries. In the case of rechargeable batteries, do not use charged and discharged batteries together. Do not use batteries of different types or brands together.
- If you do not intend to use the camera for a long period of time, remove the batteries from the camera. (Note that if the camera is left with the batteries removed, the time and date settings are cleared.)
- The batteries may feel warm immediately after being used. Before removing the batteries, switch the camera off and wait until the batteries cool down.
- When replacing the batteries, always fit 2 new batteries. Here, 'new batteries' refers to either recently purchased unused alkaline batteries, or Ni-MH (nickel metal hydride) batteries that have recently been fully recharged together.
- In cold locations (at temperatures of +10°C/+50°F or below), battery performance deteriorates and the time for which they can be used shortens markedly. This is particularly true of alkaline batteries. In cold conditions, put the batteries in your pocket or a similar place to warm them before loading them into the camera. If you use a body warmer to warm the batteries, ensure that they are not in direct contact with the warmer.

- Soil (such as fingerprints) on the battery terminals can markedly reduce the number of available shots. Carefully wipe the battery terminals clean with a soft dry cloth before loading the batteries.

- ⚠ If any liquid at all leaks from the batteries, wipe the battery compartment thoroughly and then load new batteries.
- ⚠ If any battery fluid comes into contact with your hands or clothing, flush the area thoroughly with water. Note that battery fluid can cause loss of eyesight if it gets into your eyes. If this occurs, do not rub your eyes. Flush the fluid out with clean water and contact your physician for treatment.

Disposing of Batteries

When disposing of batteries, do so in accordance with your local waste disposal regulations.

Notes on Small Rechargeable Batteries (Ni-MH batteries)

- Always use the special battery charger to charge AA-size Ni-MH batteries. Charge the batteries as described in the instructions provided with the battery charger.
- Do not use the battery charger to charge batteries other than those specified for use with the charger.
- Note that the batteries may feel warm immediately after being charged.
- Ni-MH batteries are not charged at shipment. Be sure to charge the batteries before using them.
- The camera mechanism is such that it draws a minute amount of current even when the camera is switched off. Take particular care not to leave Ni-MH batteries in the camera for a long period of time as they can become

excessively discharged and may no longer be usable even when charged.

- Ni-MH batteries self-discharge even when not used. Always charge Ni-MH batteries before using them. If the time for which a battery provides power shortens markedly when it has been correctly charged, this indicates that the battery has reached the end of its effective life and should be replaced.
 - Soiling (fingerprints, etc) on the terminals of Ni-MH batteries can greatly reduce the number of available shots. When this occurs, clean the terminals carefully with a soft dry cloth. Then use up the remaining charge in the batteries and recharge them.
 - Newly purchased batteries or batteries that have been left unused for an extended period may not be fully charged. (This is indicated by the immediate display of the battery low warning or a low number of available shots.) This is a normal characteristic of the batteries and does not indicate a fault. Repeatedly charging and using the batteries 3 or 4 times will restore them to a normal condition.
 - If you repeatedly charge a Ni-MH battery before it is fully discharged, it will suffer from the "memory effect"*, causing the battery low warning to appear while there is still ample charge remaining in the battery. To restore the batteries to their normal condition, use up all the charge in the batteries before recharging them.
- *Memory effect: A phenomenon affecting the battery characteristics such that the apparent battery capacity decreases.

Notes on Using the AC Power Adapter

Always use the AC-3V AC Power Adapter AC-3V (sold separately) with the FinePix A201 Digital Camera.

The use of an AC power adapter other than the AC-3V could result in damage to your camera.

- Ensure that you do not touch the contact areas on the AC power adapter against any other metal object as this could cause a short circuit.
- Do not plug the AC power adapter into the USB socket as this could damage your camera.
- Do not plug in the AC power adapter while you are operating the camera using batteries. Switch the camera off first.
- Do not load the batteries while you are operating the camera using the AC power adapter. Switch the camera off first.
- If you disconnect the AC power adapter when there are no batteries in the camera, the date may be cleared. If this occurs, reset the date.

■SmartMedia

The SmartMedia card supplied with your FinePix A201 camera is a new image recording medium developed especially for use in digital cameras. Each SmartMedia card contains a built-in semiconductor memory chip (NAND flash memory) which is used for storing digital image data.

Because the data is stored electronically, the stored image data can be erased from the card and new data recorded.

■SmartMedia with IDs

The SmartMedia ID is a SmartMedia that has an individually assigned identification number. SmartMedia ID cards can be used with devices that use ID numbers for copyright protection or other purposes. This camera accepts SmartMedia ID cards in the same way as conventional SmartMedia cards.

■Storing Data

In the situations listed below, recorded data may be erased (destroyed). Please note that Fuji Photo Film Co., Ltd. accepts no responsibility whatsoever for the loss (destruction) of recorded data.

- *When the SmartMedia is used incorrectly by the owner or a third party
- *When the SmartMedia is exposed to static electricity or electrical noise

*When the SmartMedia cover is opened or the SmartMedia removed and the camera is then switched off during data recording, during data erasing (SmartMedia formatting) or during frame advance when images are being played back.

**Back up important data onto another medium.
(MO disk, floppy disk, hard disk, etc.)**

■Notes on Handling SmartMedia

- Take care to hold the SmartMedia straight when you load it into your camera.
- Never remove the SmartMedia or switch the camera off during data recording, during data erasing (SmartMedia formatting) or during frame advance when images are being played back. These actions could result in damage to the SmartMedia.
- Use only the SmartMedia specified for use with the FinePix A201. The use of other SmartMedia could damage the camera.
- SmartMedia are precision electronic devices. Do not bend, drop, or subject SmartMedia to excessive shocks.
- Do not use or store SmartMedia in environments likely to be affected by strong static electricity or electrical noise.

- Do not use or store SmartMedia in very hot, humid or corrosive environments.
- Take care not to touch the SmartMedia's contact area or allow the area to become soiled. Use a dry lint-free cloth to wipe away any soiling that does occur.
- To avoid damage caused by static electricity, always use the special static-free case provided during transportation or storage, or keep the SmartMedia in a storage case if available.
- Do not carry SmartMedia in locations such as a trouser pocket. This could subject the SmartMedia to excessive force when you sit down, thereby damaging the SmartMedia.
- The SmartMedia may feel warm when it is removed from the camera after extended periods of picture taking or image viewing. This is normal and does not indicate a fault.
- Inserting a SmartMedia that is charged with static electricity into your camera may result in a camera malfunction. If this occurs, switch the camera off and then on again.
- Affix the label onto the designated area of the card. Do not use third-party labels as this can lead to problems when the card is inserted or removed.
- When you attach the label, take care that it does not cover any of the write-protect area.

Notes on Using SmartMedia with a PC







- If you intend to take photos using a SmartMedia that has been used on a PC, format the SmartMedia on your camera.
- When you format a SmartMedia in the camera and then shoot and record images, a directory (folder) is automatically created. Image data is then recorded in this directory.
- Do not change or delete the directory (folder) names or file names on the SmartMedia from your PC as this will make it impossible to use the SmartMedia in your camera.
- Always use the camera to erase image data on a SmartMedia.
- To edit image data, copy the image data to the PC's hard disk and then edit the copied data.

Specifications

Type	Image memory card for digital cameras (SmartMedia)
Operating voltage	3.3V
Conditions for use	Temperature: 0°C to +40°C (+32°F to +104°F)
	Humidity: 80% or less (no condensation)
Dimensions	37 mm × 45 mm × 0.76 mm (1.45 in. × 1.77 in. × 0.03 in.) (W × H × D)

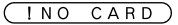

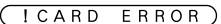
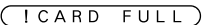

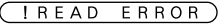
Warning Displays

▶ The table below lists the warnings that are displayed on the LCD monitor

Warning Displayed	Explanation	Remedy
 (Lit red)  (Flashing red)	The batteries in the camera are fully depleted or very low on charge.	Replace the batteries or have new batteries ready.
	There is no SmartMedia loaded, or the SmartMedia loaded is a 5-volt card.	Load the SmartMedia (3.3V) in the correct direction.
	<ul style="list-style-type: none"> The SmartMedia is not formatted. The SmartMedia contact area is soiled. Camera fault. 	<ul style="list-style-type: none"> Wipe the contact area on the SmartMedia with a soft dry cloth. It may be necessary to format the SmartMedia. If the error message is still displayed, replace the SmartMedia. Contact your FUJIFILM dealer.
	<ul style="list-style-type: none"> The SmartMedia contact area is soiled. The SmartMedia is damaged. The SmartMedia format is incorrect. Camera fault. 	<ul style="list-style-type: none"> Wipe the contact area on the SmartMedia with a soft dry cloth. It may be necessary to format the SmartMedia. If the error message is still displayed, replace the SmartMedia. Contact your FUJIFILM dealer.
	The SmartMedia is fully recorded.	Erase some images or use a SmartMedia that has ample free space.
	The SmartMedia is write-protected.	Use a SmartMedia that is not write-protected.
	<ul style="list-style-type: none"> An attempt was made to playback a frame not recorded on this camera. The SmartMedia contact area is soiled. You attempted to play a movie with a recording time longer than 20 seconds. 	<ul style="list-style-type: none"> Images cannot be played back. Wipe the contact surface on the SmartMedia thoroughly with a soft, dry cloth. In some cases, you may have to format the SmartMedia. You cannot play back movies that are more than 20 seconds long.

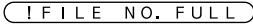
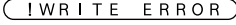
Warning Displays

► The table below lists the warnings that are displayed on the LCD monitor

Warning Displayed	Explanation	Remedy
	The playback frame number has reached 999–9999.	Take the shot using a formatted SmartMedia.
	<ul style="list-style-type: none"> •The data could not be recorded due to a SmartMedia error or a connection error between the SmartMedia and camera. •The photographed image cannot be recorded as it is too large to fit in the available space on the SmartMedia. 	<ul style="list-style-type: none"> •Re-insert the SmartMedia or switch the camera off and then on again. •Use a new SmartMedia.
	There is a strong likelihood of camera shake because the shutter speed is slow.	Use flash photography. However, a tripod should be used for some scenes and modes.
	A protected frame was erased.	Protected files cannot be erased. Unprotect the frame using the camera on which the protection was first applied.
	DPOF settings are specified for an image you tried to erase.	To erase the image, specify "RESET" as the DPOF setting (►P.50).
	Prints were specified for more than 1000 frames in the DPOF frame settings.	The maximum number of frames for which prints can be specified on the same SmartMedia is 999.

Troubleshooting

► If you think the camera is faulty, check the following once more

Problem	Cause	Remedy
No power.	<ul style="list-style-type: none"> •The battery is exhausted. •The AC power adapter plug has come out of the power outlet. 	<ul style="list-style-type: none"> •Replace the batteries. •Plug the adapter back in.
Power cuts out during operation.	<ul style="list-style-type: none"> •The battery is exhausted. 	<ul style="list-style-type: none"> •Replace the batteries.
Battery runs out quickly.	<ul style="list-style-type: none"> •You are using the camera in extremely cold conditions. •The terminals are soiled. •The battery is flat. 	<ul style="list-style-type: none"> •Put the battery in your pocket or another warm place to heat it and then load it into the camera just before you take a picture. •Wipe the battery terminals with a clean, dry cloth. •Purchase new batteries.
No photograph is taken when the shutter button is pressed.	<ul style="list-style-type: none"> •No SmartMedia is loaded. •The SmartMedia is fully recorded. •The SmartMedia is write-protected. •The SmartMedia is not formatted. •The SmartMedia contact area is soiled. •The SmartMedia is damaged. •The Power Save function has switched the camera off. •The battery is exhausted. 	<ul style="list-style-type: none"> •Load a SmartMedia. •Insert a new SmartMedia or erase some unwanted frames. •Remove the write-protection. •Format the SmartMedia. •Wipe the SmartMedia contact area with a clean dry cloth. •Load a new SmartMedia. •Switch the camera on. •Purchase new batteries.

Troubleshooting

▶ If you think the camera is faulty, check the following once more

Problem	Cause	Remedy
Can't use the flash to take pictures.	<ul style="list-style-type: none"> •The flash is set to Suppressed Flash mode. •You pressed the shutter button while the flash was charging. •The battery is exhausted. 	<ul style="list-style-type: none"> •Set the flash to Auto, Red-Eye Reduction or Forced Flash mode. •Wait until charging is completed before pressing the shutter button. •Load a new battery.
The playback image is too dark even though the flash was used.	<ul style="list-style-type: none"> •The subject is too far away. •Your fingers are obscuring the flash or flash control sensor. 	<ul style="list-style-type: none"> •Move closer to the subject. •Hold the camera correctly.
The image is blurred.	<ul style="list-style-type: none"> •The lens is dirty. •You photographed a distant subject with the macro selector switch set to "👁". •You took a close-up shot with the macro selector switch set to "▲". 	<ul style="list-style-type: none"> •Clean the lens. •Cancel Macro mode. •Set the camera to Macro mode.
There is speckling on the image.	<ul style="list-style-type: none"> •The shot was taken with a slow shutter speed (long exposure) in a high-temperature environment. 	<ul style="list-style-type: none"> •This is a characteristic of CCDs and does not indicate a camera fault.
I can't format the SmartMedia.	<ul style="list-style-type: none"> •The SmartMedia is write-protected. 	<ul style="list-style-type: none"> •Remove the write-protection. Peel off the write-protect sticker)

Problem	Cause	Remedy
The ERASE ALL function does not erase all the frames.	<ul style="list-style-type: none"> •The frame is protected. •DPOF settings are specified for some frames. 	<ul style="list-style-type: none"> •Unprotect the frame using the camera on which the protection was first applied. •Cancel the DPOF settings for the frame and try again.
Frame erase does not erase the frame.		
Nothing happens when I use the Mode switch.	<ul style="list-style-type: none"> •Camera malfunction. •The battery exhausted. 	<ul style="list-style-type: none"> •Briefly remove the batteries or disconnect the AC power adapter. Then reload the batteries or reconnect the AC power adapter and try again. •Purchase new batteries.
When the camera is connected to a personal computer (PC), the shot image appears on the camera's LCD monitor.	<ul style="list-style-type: none"> •The special USB cable is not connected correctly to the PC or camera. •The PC is not switched on. 	<ul style="list-style-type: none"> •Set up the camera and USB cable correctly. •Switch the PC on.
The camera no longer works correctly.	<ul style="list-style-type: none"> •The camera has suffered an unforeseen problem. 	<ul style="list-style-type: none"> •Remove the battery briefly and then reload the battery and try again.

Specifications

System

- **Model:** Digital Camera FinePix A201
- **CCD sensor:**
1/2.7-inch square pixel CCD with RGB Filter
Number of total pixels: 2.11 million pixels
- **Number of effective pixels:** 2.0 million pixels
- **Resolution:**
1600 × 1200 pixels/1280 × 960 pixels/640 × 480 pixels
- **File format:**
Still image: JPEG (Exif Ver.2.1), DPOF-compatible
Movie: AVI format, Motion JPEG
*Design rule for Camera File system Compliant
- **Viewfinder**
Inverted Galilean finder; Frame coverage: 80%
- **Lens**
Fujinon optical fixed-focus lens
- **Storage media**
SmartMedia (3.3V, 2 to 128MB)
- **Focus distance**
f=5.5 mm (equivalent to 36 mm on a 35 mm camera)
- Number of frames recorded

- **Exposure control**
64 zones TTL metering, Program AE
(exposure compensation available in Manual mode)
- **Sensitivity**
Equivalent to ISO 100
- **White balance**
Auto (7 positions selectable in Manual mode)
- **Focal range**
Normal: Approx. 80 cm/2.6 ft. to infinity
Macro: Approx. 8 cm – 13 cm/3.1 in. – 5.1 in.
- **Shutter speeds**
Variable-speed, 1/2 sec. to 1/1000 sec. (combined with mechanical shutter)
- **Flash (Auto flash using flash control sensor)**
Effective range : Approx. 0.8 m – 3.0 m (2.6 ft. – 9.8 ft.)
Flash modes : Auto, Red-Eye Reduction, Forced Flash, Suppressed Flash, Slow Synchro
- **LCD monitor**
1.6-inches, 55,000-pixels D-TFD
- **Self-Timer**
10 sec. timer clock

File Size	[2M] 1600 × 1200			[1M] 1280 × 960			[VGA] 640 × 480	Movie
	FINE	NORMAL	BASIC	FINE	NORMAL	NORMAL	—	
Image Data Size	Approx.770KB	Approx.390KB	Approx.200KB	Approx.620KB	Approx.320KB	Approx.130KB	—	—
4MB (MG-4S)	4	9	19	6	12	30	Approx. 23 sec.	
8MB (MG-8S)	10	19	39	12	25	61	Approx. 47 sec.	
16MB (MG-16S/SW)	20	39	75	25	49	122	Approx. 94 sec.	
32MB (MG-32S/SW)	41	79	152	50	99	247	Approx.191 sec.	
64MB (MG-64S/SW)	82	159	306	101	198	497	Approx.385 sec.	
128MB (MG-128SW)	166	319	613	204	398	997	Approx.774 sec.	

Input/Output Terminals

- **(Special USB) socket**
USB (1) for image data output with a personal computer
- **DC IN 3V (Power input) socket**
Socket for specified AC power adapter

Power Supply and Others

- **Power supply**
Use one of the following:
 - 2AA-size alkaline batteries
 - 2AA-size Ni-MH (nickel metal hydride) batteries (sold separately)
 - AC Power Adapter AC-3V (sold separately)
- **No. of available shots using battery (battery life)**

Battery type	With LCD monitor ON	With LCD monitor OFF
Alkaline batteries	Approx. 80 frames	Approx. 150 frames
Ni-MH batteries HR-3UF	Approx. 150 frames*	Approx. 250 frames*

(Condition: Power saving mode ON, with fully charged battery (Ni-MH))
This indicates the number of available frames shot consecutively at room temperature with a flash use rate of 50%. Note that these figures may vary depending on the ambient temperature and the amount of charge in the battery. The number of available shots or available shooting time will be lower in cold conditions.

- **Conditions for use**
Temperature: 0°C to +40°C (+32°F to +104°F); 80% humidity or less (no condensation)

- **Camera dimensions (W/H/D)**
98.5 mm × 64.5 mm × 40.5 mm/3.9 in. × 2.5 in. × 1.6in.
(not including accessories and attachments)
- **Camera mass (weight)**
Approx. 145 g/5.1 oz.
(not including accessories, batteries or SmartMedia)
- **Weight for photography**
Approx. 200 g/7.1 oz.
(including batteries and SmartMedia)
- **Accessories**
See P.7
- **Optional Accessories**
See P.65, 66

* These specifications are subject to change without notice.
FUJIFILM shall not be held liable for damages resulting from errors in this Owner's Manual.
* The LCD monitor on your digital camera is manufactured using advanced high-precision technology. Even so, small bright points and anomalous colors (particularly around text) may appear on the monitor. These are normal display characteristics and do not indicate a fault with the monitor. This phenomenon will not appear on the recorded image.
* The operation error may be caused in a digital camera by the strong radio interference (i. e. electric fields, static electricity, line noise, etc.).

Explanation of Terms

DPOF: Digital Print Order Format

DPOF is a format used for recording information on a storage media (image memory card, etc.) that allows you to specify which of the frames shot using a digital camera are printed and how many prints are made of each image.

EV:

A number that denotes exposure. The EV is determined by the brightness of the subject and sensitivity (speed) of the film or CCD. The number is larger for bright subjects and smaller for dark subjects. As the brightness of the subject changes, a digital camera maintains the amount of light hitting the CCD at a constant level by adjusting the aperture and shutter speed. When the amount of light striking the CCD doubles, the EV increases by 1. Likewise, when the light is halved, the EV decreases by 1.

JPEG:

Joint Photographics Experts Group

A file format used for compressing and saving color images. The compression ratio can be selected, but the higher the compression ratio, the poorer the quality of the expanded image.

Motion JPEG:

A type of AVI (Audio Video Interleave) file format that handles images and sound as a single file. Images in the file are recorded in JPEG format. Motion JPEG can be played back by QuickTime 3.0 or later.

PC Card:

A generic term for cards that meet the PC Card Standard.

PC Card Standard:

A standard for PC cards determined by the PCMCIA.

PCMCIA:

Personal Computer Memory Card International Association (US).

White Balance:

Whatever the kind of the light, the human eye adapts to it so that a white object still looks white. On the other hand, devices such as digital cameras see a white subject as white by first adjusting the color balance to suit the color of the ambient light around the subject. This adjustment is called matching the white balance. A function that automatically matches the white balance is called an **Automatic White Balance function**.

Safety Notes

- To ensure that you use your FinePix A201 camera correctly, read these Safety Notes and your Owner's Manual carefully beforehand.
- After reading these Safety Notes, store them in a safe place.

About the Icons

The icons shown below are used in this document to indicate the severity of the injury or damage that can result if the information indicated by the icon is ignored and the product is used incorrectly as a result.



WARNING

This icon indicates that death or serious injury can result if the information is ignored.



CAUTION

This icon indicates that personal injury or material damage can result if the information is ignored.

The icons shown below are used to indicate the nature of the information which is to be observed.



Triangular icons notify the user of information requiring attention ("Important").



Circular icons with a diagonal bar notify the user that the action indicated is prohibited ("Prohibited").



Filled circles with an exclamation mark notify the user of an action that must be performed ("Required").



WARNING

When a fault arises, switch the camera off and then remove the batteries and disconnect the AC power adapter.

Continued use of the camera when it is emitting smoke, is emitting any unusual odor, or is in any other abnormal state can cause a fire or electric shock.

- Contact your FUJIFILM dealer.



Unplug from power socket.

Do not allow water or foreign objects to enter the camera.

If water or foreign objects get inside the camera, switch the camera off, remove the battery and disconnect and unplug the AC power adapter.

Continued use of the camera can cause a fire or electric shock.

- Contact your FUJIFILM dealer.



Do not place the camera on an unstable surface.

This can cause the camera to fall or tip over and cause injury.







Do not use the camera in the bathroom or shower.







This can cause a fire or electric shock.













Do not use in the bathroom or shower.

Safety Notes

 WARNING	
<p>Never attempt to modify or disassemble the camera. (Never open the casing.) Do not use the camera when it has been dropped or the casing is damaged. This can cause a fire or electric shock. ● Contact your FUJIFILM dealer.</p>	 Do not disassemble.
<p>Never attempt to take pictures while in motion. Do not use the camera while you are walking or operating a moving car or other vehicle. This can result in you falling down or being involved in a traffic accident.</p>	
<p>Do not heat, modify or attempt to disassemble the batteries. Do not drop or subject the batteries to impacts. Do not attempt to recharge lithium or alkaline batteries. Do not store the batteries with metallic products. Any of these actions can cause the batteries to burst or leak and cause fire or injury as a result.</p>	

 WARNING	
<p>Do not touch any metal parts of the camera during a thunderstorm. This can cause an electric shock due to induced current from the lightning discharge.</p>	
<p>Do not use the batteries except as specified. Load the batteries with the poles positioned as indicated by the ⊕ and ⊖ marks.</p>	
<p>Use only the batteries or AC power adapter specified for use with this camera. The use of other power sources can cause a fire.</p>	
<p>If the battery leaks and fluid gets into your eyes or comes into contact with your skin or clothing, this can cause injury or loss of eyesight. Immediately flush the affected area thoroughly with clean water and seek medical treatment.</p>	
<p>When discarding or storing batteries, cover the battery terminals with insulation tape. ● Contact with other metallic objects or batteries could cause the batteries to ignite or burst.</p>	

 CAUTION	
<p>Keep out of the reach of small children. This product could cause injury in the hands of a child.</p>	
<p>Do not use this camera in locations severely affected by oil fumes, steam, humidity or dust. This can cause a fire or electric shock.</p>	
<p>Do not leave this camera in places subject to extremely high temperatures. Do not leave the camera in locations such as a sealed vehicle or in direct sunlight. This can cause a fire.</p>	
<p>Do not place heavy objects on the camera. This can cause the heavy object to tip over or fall and cause injury.</p>	
<p>Do not move the camera while the AC power adapter is still connected. This can damage the power cord or cables and cause a fire or electric shock.</p>	

 CAUTION	
<p>Do not cover or wrap the camera or the AC power adapter in a cloth or quilt. This can cause heat to build up and distort the casing or cause a fire.</p>	
<p>Remove the batteries and disconnect the AC power adapter when you are cleaning the camera or if you intend to leave the camera unused for a long period. Failure to do so can cause a fire or electric shock.</p>	
<p>Using a flash too close to a person's eyes may temporarily affect the eyesight. Take particular care when photographing infants and young children.</p>	
<p>Request regular internal testing and cleaning for your camera. Build-up of dust in your camera can cause a fire or electric shock. ● Contact your FUJIFILM dealer to request internal cleaning every 2 years.</p>	



FUJI PHOTO FILM CO., LTD.

26-30, Nishiazabu 2-chome, Minato-ku, Tokyo 106-8620, Japan

Printed in Japan

Printed on recycled paper.

FGS-103107-FG