

FUJIFILM

digital
Tools for the imagination.

DIGITAL CAMERA

FinePix1300

1.3
MEGA
PIXELS



Getting Ready

1

Basic Photography

2

Advanced Features
Photography

3

Advanced Features
Playback

4

Settings

5

OWNER'S MANUAL

This manual will show you how to use your FUJIFILM DIGITAL CAMERA FinePix1300 correctly. Please follow the instructions carefully.

BB11884-200(1)



Warning

For customers in the U.S.A.

FCC Statement

This device complies with part 15 of the FCC Rules. Operation is subject to the following two conditions:(1) This device may not cause harmful interference, and (2) this device must accept any interference received, including interference that may cause undesired operation.

CAUTION

This equipment has been tested and found to comply with the limits for a Class B digital device, pursuant to Part 15 of the FCC Rules. These limits are designed to provide reasonable protection against harmful interference in a residential installation. This equipment generates, uses, and can radiate radio frequency energy and, if not installed and used in accordance with the instructions, may cause harmful interference to radio communications. However, there is no guarantee that interference will not occur in a particular installation. If this equipment does cause harmful interference to radio or television reception, which can be determined by turning the equipment

off and on, the user is encouraged to try to correct the interference by one or more of the following measures:

- Reorient or relocate the receiving antenna.
- Increase the separation between the equipment and receiver.
- Connect the equipment into an outlet on a circuit different from that to which the receiver is connected.
- Consult the dealer or an experienced radio/TV technician for help.

You are cautioned that any changes or modifications not expressly approved in this manual could void your warranty.

For customers in Canada

CAUTION

This Class B digital apparatus complies with Canadian ICES-003.

Please read the Safety Notes (⇒P.76) and make sure you understand them before using the camera.

EC Declaration of Conformity

We
Name : Fuji Photo Film (Europe) G.m.b.H.
Address : Heesenstrasse 31
40549 Dusseldorf, Germany

declare that the product
Product Name : FUJIFILM DIGITAL CAMERA FinePix1300
Manufacture's Name : Fuji Photo Film Co., Ltd.
Manufacture's Address : 26-30, Nishiazabu 2-chome, Minato-ku,
Tokyo 106-8620, Japan

is in conformity with the following Standards

Safety : EN60950
EMC : EN55022 : 1998 Class B
EN55024 : 1998
EN61000-3-2 : 1995 + A1:1998 + A2:1998

following the provision of the EMC Directive (89/336/EEC, 92/31/EEC and 93/68/EEC) and Low Voltage Directive (73/23/EEC).



Dusseldorf, Germany

Place

August 1, 2000

Date

Signature/Managing Director



Bij dit produkt zijn batterijen geleverd. Wanneer deze leeg zijn, moet u ze niet weggooien maar inleveren als KCA

Contents

Warning	2
EC Declaration of Conformity	3
Preface	6
Camera Features and Accessories	7
Nomenclature	8

1 Getting Ready

PREFACE	11
● Selecting the Language	11
● Attaching the Strap	11
SELECTING THE POWER SUPPLY	12
● Using Batteries	12
● Using the AC Power Adapter (sold separately) ...	13
LOADING AND REMOVING THE SmartMedia™	14
● SmartMedia™	14
● Loading the SmartMedia™	14
● Removing the SmartMedia™	15
SWITCHING ON AND OFF	16
SETTING THE DATE AND TIME	17

2 Basic Photography

📷 TAKING PICTURES (AUTO MODE)	19
● Number of available frames	23
▶ VIEWING YOUR IMAGES (PLAYBACK) ...	24
▶ PLAYBACK ZOOM	25
▶ MULTI-FRAME PLAYBACK	26
▶ → 🗑 ERASING SINGLE FRAME	27

3 Advanced Features Photography

📷 ADVANCED PHOTOGRAPHY	29
■ Photography menu settings	29

PHOTOGRAPHY MENU

USING THE PHOTOGRAPHY MENU	30
SELECTING THE MODE	31
FLASH PHOTOGRAPHY	32
Auto Flash	32
👁 Red-Eye Reduction	33
⚡ Forced Flash	33
🚫 Suppressed Flash	34
⚡ Slow Synchro	34

📷 CONTINUOUS SHOOTING	35
🕒 SELF-TIMER PHOTOGRAPHY	36
📷 SETTING THE BRIGHTNESS (EXPOSURE COMPENSATION)	38
📷 SETTING THE WHITE BALANCE	39
🌸 MACRO (CLOSE-UP) PHOTOGRAPHY ...	40
📷 USING THE DIGITAL TELEPHOTO	41

4 Advanced Features Playback

▶ ADVANCED PLAYBACK	42
---------------------------	----

PLAYBACK MENU

🗑 ERASING SINGLE • ALL FRAMES /FORMATTING	43
🔑 SETTING AND REMOVING SINGLE FRAME PROTECTION	45
🔑 SETTING AND REMOVING PROTECTION FOR ALL FRAMES	47
📷 HOW TO SPECIFY PRINT OPTIONS ...	49
📷 DPOF DATE SETTING	50
📷 DPOF FRAME SET/RESET	51
📷 DPOF SET ALL/RESET ALL	53

5 Settings

📷 SET-UP MODE	54
SETTING THE FILE SIZE AND QUALITY	56
FRAME NO. MEMORY	57
ADJUSTING THE LCD MONITOR BRIGHTNESS ...	58

System Expansion Options	59
Downloading Images to a Personal Computer	60
Accessories Guide	62
Explanation of Terms	64
Notes on Using Your Camera Correctly ...	65
Notes on the Power Supply	66
● Applicable Batteries	66
● Notes on the Batteries	66
● Notes on Using the AC Power Adapter ...	67
Notes on the SmartMedia™	68
Warning Displays	70
Troubleshooting	72
Specifications	74
Safety Notes	76

Preface

■ Test Shots Prior to Photography

For particularly important photographs (such as weddings and overseas trips), always take a test photograph to check that the camera is functioning normally.

- Fuji Photo Film Co., Ltd cannot accept liability for any incidental losses (such as the costs of photography or the loss of income from photography) incurred as a result of faults with this product.

■ Notes on Copyright

Images recorded using your digital camera system cannot be used in ways that infringe copyright laws without the consent of the owner, unless intended only for personal use. Note that some restrictions apply to the photographing of stage performances, entertainments and exhibits, even when intended purely for personal use. Users are also asked to note that the transfer of memory cards containing images or data protected under copyright laws is only permissible within the restrictions imposed by those copyright laws.

■ Liquid Crystal

If the LCD monitor or LCD panel is damaged, take particular care with the liquid crystal in the monitor or panel. If any of the following situations arise, take the urgent action indicated.

- If liquid crystal comes in contact with your skin
Wipe the area with a cloth and then wash thoroughly with running water and soap.
- If liquid crystal gets into your eye
Flush the affected eye with clean water for at least 15 minutes and then seek medical assistance.

- If liquid crystal is swallowed

Flush your mouth thoroughly with water. Drink large quantities of water and induce vomiting. Then seek medical assistance.

■ Notes on Electrical Interference

If the camera is used in hospitals or aircrafts, please note that it may cause interference with other equipment in the hospital or aircraft.

For details, please check with the applicable regulations in that area.

■ Handling Your Digital Camera

This camera contains precision electronic components. To ensure that images are recorded correctly, do not subject the camera to impact or shock while an image is being recorded.

■ Trademark Information

- IBM PC/AT is a registered trademark of International Business Machines Corp. of the USA.
- iMac and Macintosh are trademarks of Apple Computer, Inc.
- MS-DOS and Windows are registered trademarks of the Microsoft Corporation registered in the USA and other countries.
Windows is an abbreviated term referring to the Microsoft Windows Operating System.
- SmartMedia is a trademark of Toshiba Corporation.
- Other company or product names are trademarks or registered trademarks of their respective companies.

Camera Features and Accessories

Features

- Superb high-quality images from the 1.31-megapixel CCD and high-resolution Fujinon lens
- Capable of recording images at resolutions up to 1280 × 960 pixels
- Lightweight, compact body
- 1.6-inch color LCD monitor
- Wide-angle field of view (with Macro function)
- Automatic built-in flash with high-precision wide-range flash control sensor
- Manual photography mode that allows fine tuning of the camera settings
- Digital 2 × telephoto for photography and 1.2 × to 4 × zoom playback function
- Mode dial and 4-direction button for simple operation
- Compatible with 3.3V, 2MB to 64MB SmartMedia
- Date and time recording/playback function
- USB connection allows simple, high-speed image data transfer (using the enclosed interface)
- Conforms to the new standard for digital camera file system*
* Design rule for Camera File system
- Support for DPOF* simplifies print ordering
* DPOF stands for "Digital Print Order Format"

Accessories

- AA-size alkaline batteries (4)

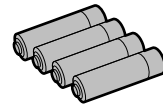

- SmartMedia (8MB,3.3V)(1)

Supplied with :

- Anti-static case (1)
- Index labels (1set)

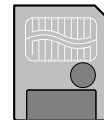

- Hand Strap (1)



- Interface Set (1)

- CD-ROM (1)
- Special USB cable (1)
- Quick Start Guide (1)

- Owner's Manual (this manual) (1)

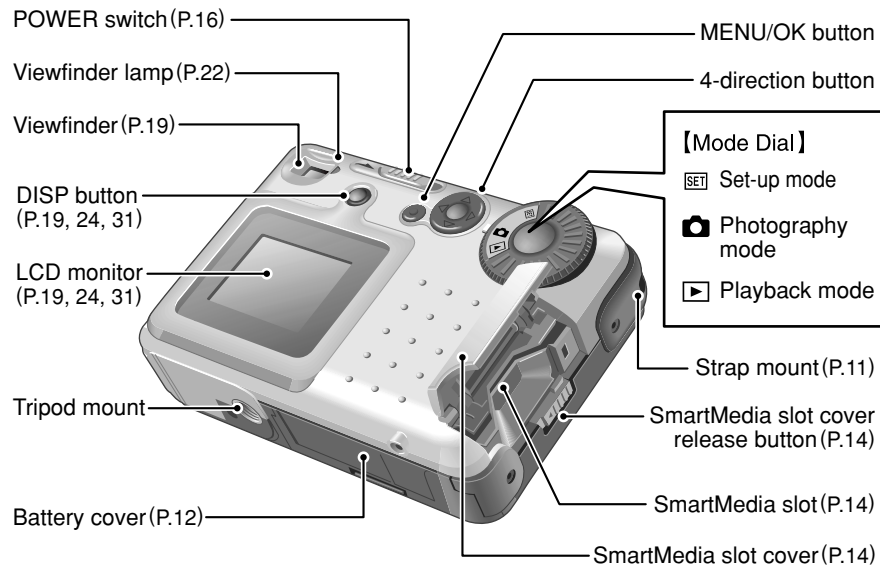
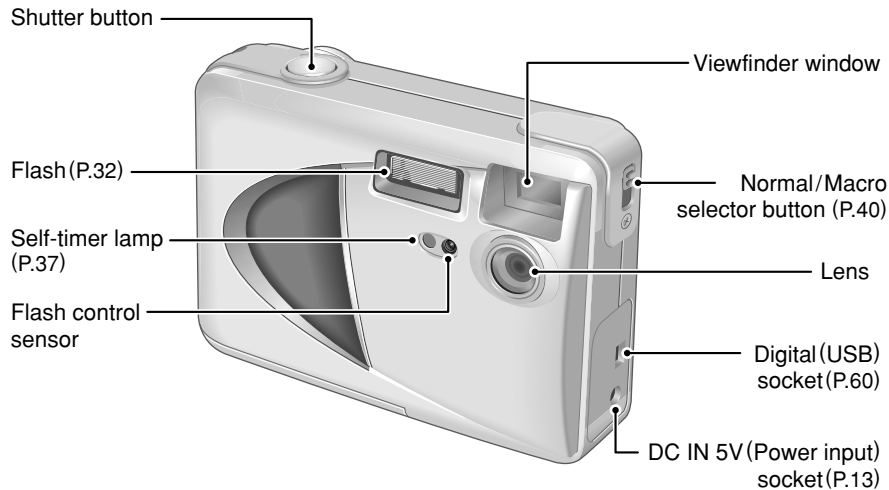

Nomenclature

Example of LCD Monitor Text Display : Shooting

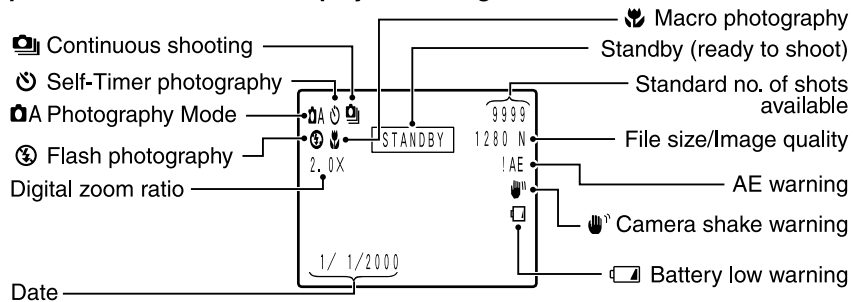

Example of LCD Monitor Text Display : Playback

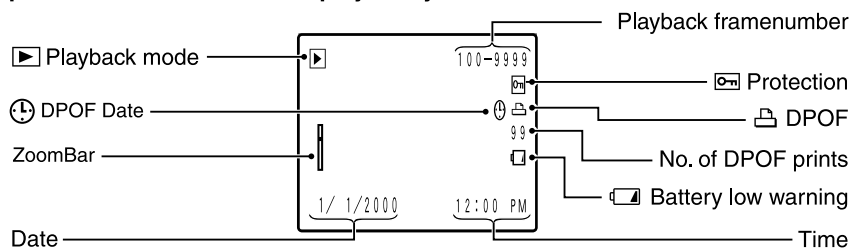

Selecting the Language

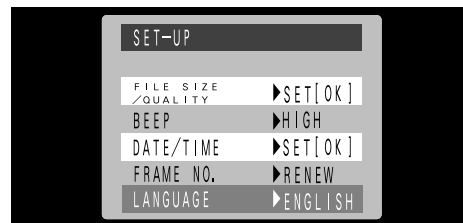

You can use the Setup screen on this camera to select English or French as the language used for screen display (→P.54). The screens in this manual are shown in English.

Attaching the Strap

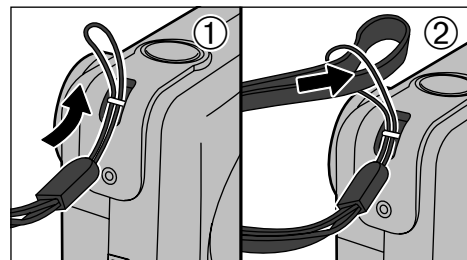

- ① Pass the loop of this cord on the end of the strap through the strap mount.
- ② Then pass the other end of the strap through the loop of the thin cord and pull the strap tight.

SELECTING THE POWER SUPPLY

Using Batteries

Use 4 AA-size alkaline, Ni-MH or Ni-Cd batteries. Do not use different types of batteries together.

■ **Number of available shots** (*with fully charged batteries)
The table below provides a guide to the number of shots that can be taken at normal temperature with 50% flash use. Note that these figures may vary depending on the camera's ambient temperature and the level of battery charge.

Battery type	With LCD monitor ON	With LCD monitor OFF
Alkaline batteries	Approx.260 frames	Approx.800 frames
Ni-MH battery HR-3UF	Approx.300 frames*	Approx.800 frames*
Ni-Cd battery KR-3UF	Approx.180 frames*	Approx.500 frames*

◆ Important Battery Information ◆

- Because different brands of alkaline batteries have different capacities, the life of some batteries (the length of time for which they can be used) may be considerably shorter than that of the alkaline batteries supplied with this camera.
- It is a characteristic of alkaline batteries in particular that the life of the battery is shorter at low temperatures (+10°C or below).
- Do not use lithium or manganese batteries in your FinePix1300 because the heat generated by the batteries could damage the camera.

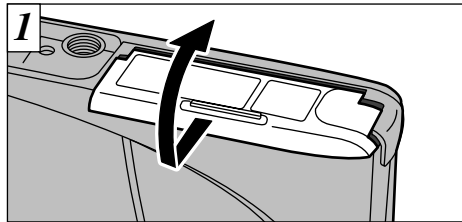

Slide the battery cover in the direction of the arrow and open the cover.

- ⚠ Soiling such as fingerprints on the battery terminals can markedly reduce the number of available shots (⇒P.67).
- ⚠ Do not use new and used batteries together.
- ⚠ Always switch the camera off when replacing the batteries. If the camera is left on, the camera settings may revert to the factory default settings.
- ⚠ The Quick Battery Charger (sold separately) is needed to recharge AA-size Ni-MH or Ni-Cd batteries (⇒P.62).
- ⚠ Once the AC power adapter has been connected or the batteries have been loaded for 10 minutes or more, the settings will be retained for roughly 20 minutes even if you remove the batteries and disconnect the AC power adapter. Check settings such as the date and time after you replace the batteries.

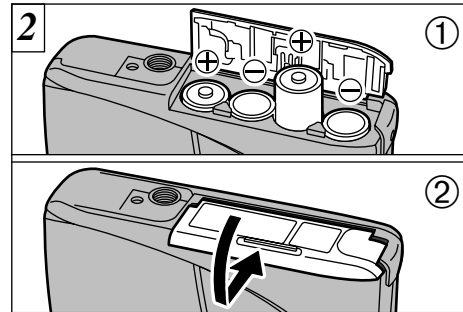

- ① Install the batteries with the correct polarity as shown.
- ② Close the battery cover as indicated by the arrow.

- ⚠ Do not use excessive force on the battery cover.
- ⚠ Take care not to drop the batteries when you open or close the battery cover.

Using the AC Power Adapter (sold separately)

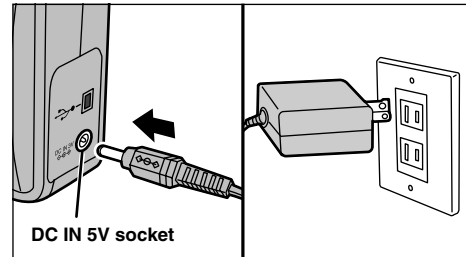

To shoot or play back images without depleting the battery charge, use the special AC Power Adapter AC-5V/AC-5VH. Check that the camera is switched off and then plug the AC power adapter connector into the "DC IN 5V socket" on the camera. Then plug the AC power adapter into the power outlet.

- ⚠ You cannot charge the batteries by connecting the AC power adapter.
- ⚠ The shapes of the plug and socket-outlet depends on the country of use.
- ⚠ Using AC power adapters other than the AC-5V/AC-5VH could damage the camera.
- ⚠ See P.67 for more information on the AC power adapter.

LOADING AND REMOVING THE SmartMedia™

SmartMedia™

■ Only use 3.3V SmartMedia.

MG-4S (4MB), MG-8S (8MB), MG-16S/SW (16MB),
MG-32S/SW (32MB), MG-64S/SW (64MB)

- ⚠ Images cannot be recorded or erased if a write-protect sticker is affixed to the SmartMedia.
- ⚠ Operation of this camera is only guaranteed when it is used with Fujifilm SmartMedia.
- ⚠ Some 3.3V SmartMedia are labelled as "3V" cards.

To record data on a SmartMedia, you must first format the SmartMedia using the FinePix1300 (→P.43).

Loading the SmartMedia™

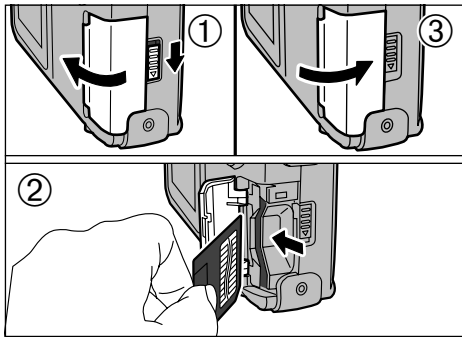

- ① Check that the camera is switched off. Then use the lock release button to unlock the slot cover and open the cover.
 - ② Push the SmartMedia firmly into the SmartMedia slot as far as it will go.
 - ③ Close the slot cover.
- ⚠ If you open the slot cover while the camera is switched on, the camera is automatically switched off to protect the SmartMedia.
 - ⚠ The SmartMedia will not slide fully into the slot if it is inserted facing the wrong way. Be careful not to apply undue force to the SmartMedia.

Removing the SmartMedia™

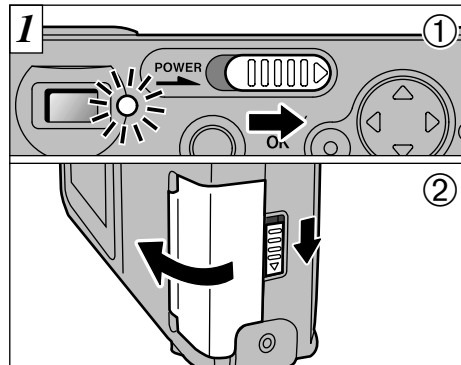

- ① Check that the viewfinder lamp is lit green before you switch the camera off (→P.16).
- ② Unlock the slot cover and then open the cover.

Always switch the camera off before opening the slot cover. Opening the slot cover while the camera is on can corrupt the image data on the SmartMedia card or damage the card itself.

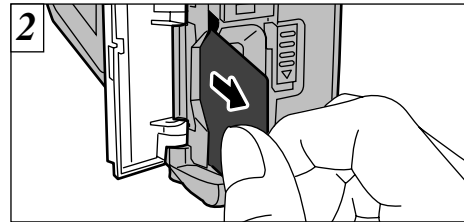

Grip the SmartMedia and pull it out.

- ⚠ To protect the SmartMedia, always store it in the special anti-static case.
- ⚠ See P.68 for more information on SmartMedia.

◆ Printing Images and Downloading Images to a Personal Computer ◆

- See P.49, 59 for information on printing your images.
- See P.59 to 61 for information on downloading your images to a personal computer.

SWITCHING ON AND OFF

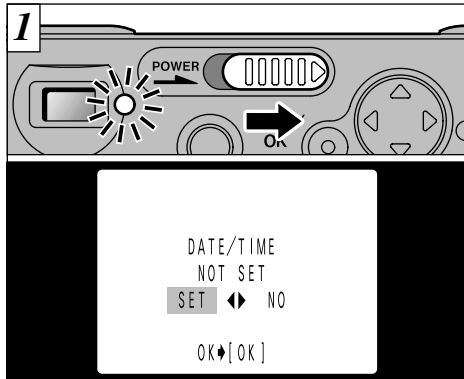

Slide the POWER switch in the direction of the arrow to switch the camera on or off. The viewfinder lamp lights [green] when you switch the camera on.

If you have not set the date, a confirmation screen appears. Press “◀” or “▶” to select the desired option and then press the “MENU/OK” button.

“SET”: The date setting screen appears. (→ P.18)

“NO” : The camera switches to Photography, Playback or Setup mode.

⚠ If you have not set the date, the confirmation screen appears every time you switch the camera on. You should set the date immediately.

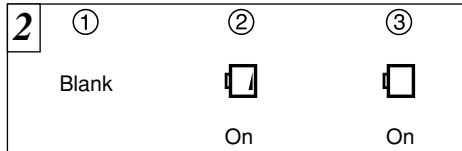

With the LCD monitor on, you can check the remaining charge in the battery.

① Battery has ample charge. (No indicator displayed.)

② Battery charge low. Replace or recharge the battery as it will run out shortly.

③ The battery is exhausted. The display will shortly go blank and the camera will stop working. Replace or recharge the battery.

⚠ If the battery charge is depleted, you may not be able to switch the LCD monitor on.

◆ Auto Power Off Function ◆

If the camera is left on for two minutes or more, the Auto Power Off function automatically switches the camera off. **Holding down the “MENU/OK” button as you switch the camera on disables the Auto Power Off function.**

SETTING THE DATE AND TIME

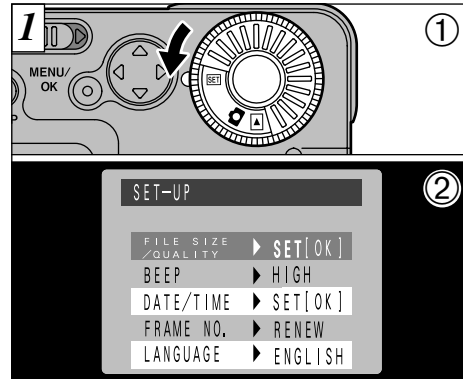

① Set the Mode dial to “SET”.

② Switch to the SET-UP screen.

If the date is cleared when you switch the camera on, a confirmation screen appears. If you selected “SET”, proceed from step ③ (→ P.18).

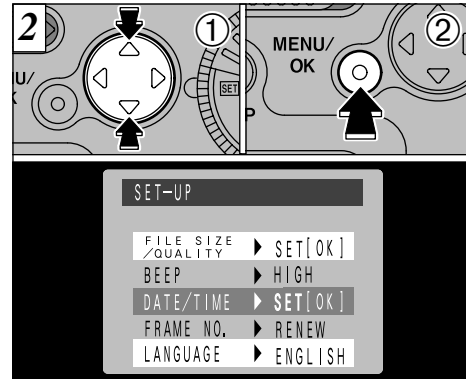

① Use the “▲▼” button to select “DATE/TIME”.

② Press the “MENU/OK” button.

⚠ Once the AC power adapter has been connected or the batteries have been loaded for 10 minutes or more, the settings will be retained for roughly 20 minutes even if you remove the batteries and disconnect the AC power adapter. Check settings such as the date and time after you replace the batteries.

⚠ See P.56 for more information on the “SET” menu.

SETTING THE DATE AND TIME

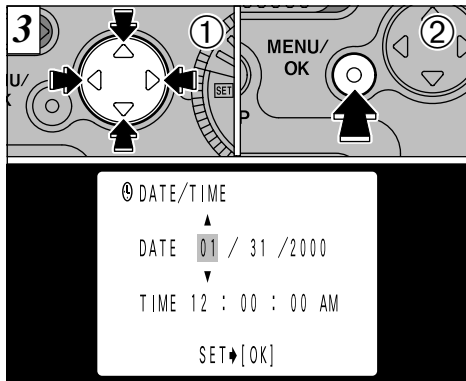

- ① Use the “◀▶” button to select the desired item and then use the “▲” and “▼” buttons to correct the setting.
- ② When you have matched the settings, press the “MENU/OK” button.

⚠ You cannot set seconds.

⚠ When the time displayed passes “12:00:00”, the AM/PM setting automatically switches.

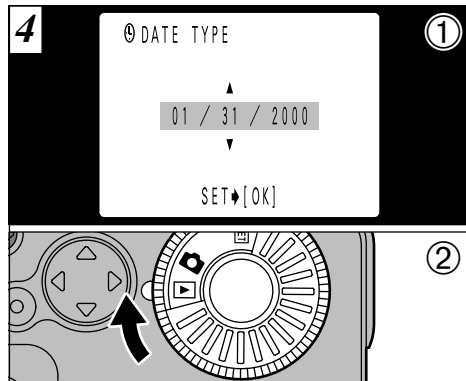

- ① Press “▲” or “▼” to select the format for the date display shown on the LCD monitor and then press the “MENU/OK” button.
 → Year.Month.Day ↔ Day.Month.Year ↔ Month/Day/Year ←
- ② Set the mode dial to “A” (Photography) or “▶” (Playback) to exit Setup mode.

⚠ In Photography mode, the date display disappears after 3 seconds.

2 Basic Photography

TAKEING PICTURES (AUTO MODE)

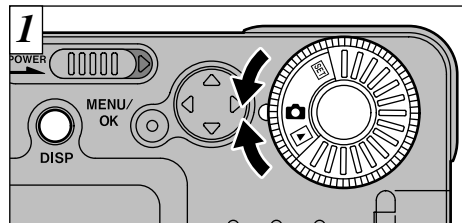

Set the mode dial to “A”.

To take pictures using the viewfinder (excluding Macro Photography), or the LCD monitor, press the “DISP” button to switch the LCD monitor on.

In the “A” Photography mode, pressing the “DISP” button changes the display status one step in a 3-step cycle from “LCD monitor ON” to “No text displayed” to “LCD monitor OFF” and so on.

- **Effective Photography Range**
Approx. 70 cm(2.3ft.) to infinity

⚠ For close-up photography, set the mode to MACRO (→P.40).

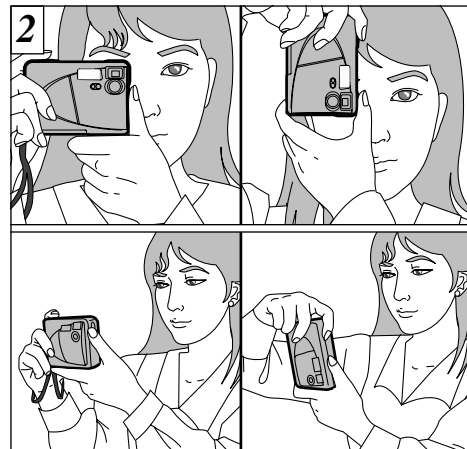

Loop the strap over your wrist, brace your elbows against your body and grip the camera firmly in both hands. When you are holding the camera on its side, hold it so that the shutter button is at the top.

📷 TAKING PICTURES (AUTO MODE)

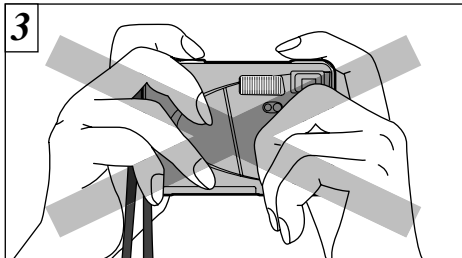

Ensure that your fingers or the camera strap do not obscure the lens, flash, or flash control sensor.

- ❗ Check that the lens is clean. If it is dirty, clean the lens as described on P.65.
- ❗ The image will be blurred if the camera moves when you take the picture (camera shake).



Use the LCD monitor or viewfinder to position the subject close to the center of the frame.

- ❗ In Photography mode, the date display disappears after 3 seconds.

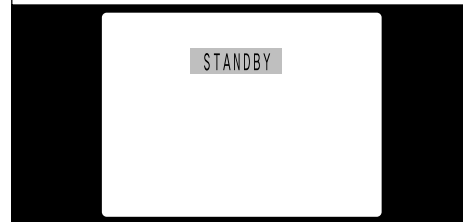
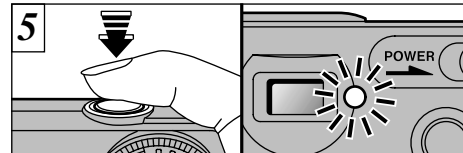

If the green viewfinder lamp stops blinking and stays lit or "STANDBY" appears on the LCD monitor when you press the shutter button down halfway, the exposure setting (AE lock) is completed (➔P.22).

- ❗ The camera will not focus at distances of 70cm (2.3 ft.) or less even when "STANDBY" is displayed.
- ❗ If you press the shutter button down fully, "STANDBY" does not appear.

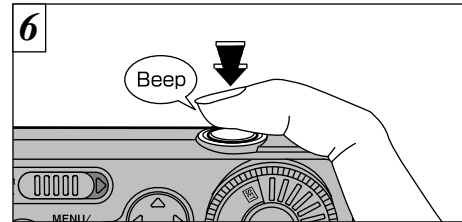

To take the picture, press the shutter button down fully without lifting your finger off it. The camera beeps and takes the picture, and the data is then recorded.

- ❗ The viewfinder lamp flashes orange while the flash is charging.
- ❗ Because the amount of image data recorded is not fixed and varies depending on the subject (level of image detail, etc.), the number of available shots may not decrease after the image is recorded, or may decrease by 2.
- ❗ See P.70 for information on the warning displays.

The viewfinder lamp glows orange while the image is being recorded and no pictures can be taken. Do not switch the camera off or open the SmartMedia slot cover during data recording, as this can cause the image data to be corrupted or lost.

📷 TAKING PICTURES (AUTO MODE)

■ AE Lock

Press the shutter button down halfway to lock the exposure settings and enable AE Lock. Using AE Lock allows you to change the composition of your shot after you set the exposure, and still get excellent results.

- 🔔 In dimly lit scenes where the subject is difficult to see using the LCD monitor, use the viewfinder to take the picture.
- 🔔 Shooting using the LCD monitor is recommended when you want accurate adjustment of the range to be shot.

■ Viewfinder Lamp Display

Color	Status	Meaning
Green	Lit	Ready to shoot
	Flashing	AE operating or camera shake warning.
Orange	Lit	Image being recorded onto the SmartMedia.
	Flashing	Flash charging
Red	Flashing	<ul style="list-style-type: none"> ● SmartMedia warning No SmartMedia loaded, SmartMedia not formatted, incorrect format, write-protect sticker used, SmartMedia full, SmartMedia error. *When the LCD monitor is switched on, details of the warning are displayed on the monitor (➡P.70).

Number of available frames

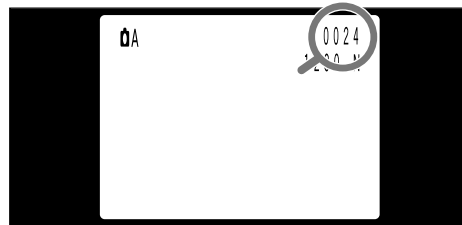

The number of available shots is displayed on the LCD monitor in the location shown in the figure at left.

- 🔔 See P.56 for information on changing the File Size (number of pixels) and Quality (compression ratio) settings.
- 🔔 At shipment, the default settings are NORMAL (for Quality) and 1280×960 (for File Size).

■ **Standard number of shots per SmartMedia** : The number of shots that can be recorded onto a SmartMedia card varies slightly depending on the type of subject. Also, the difference between the standard number of shots and the actual number of available shots increases for SmartMedia with a higher capacity.

Pixel	1280 × 960			640 × 480
	FINE	NORMAL	BASIC	NORMAL
Quality Mode				
Compression Ratio	Approx.1/4	Approx.1/8	Approx.1/16	Approx.1/8
Image Data Size	Approx.610KB	Approx.310KB	Approx.160KB	Approx.90KB
4MB (MG-4S)	6	12	23	44
8MB (MG-8S)	12	24	47	89
16MB (MG-16S/SW)	25	49	89	164
32MB (MG-32S/SW)	50	99	180	330
64MB (MG-64S/SW)	101	198	362	663

▶ VIEWING YOUR IMAGES (PLAYBACK)

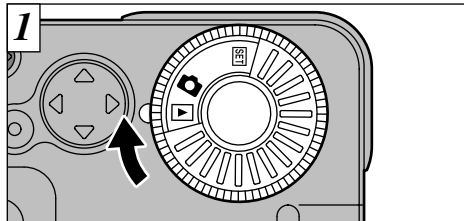

Set the mode dial to “▶”.

- ! When you set the mode dial to “▶”, the last image shot is displayed.
- ! If image on the LCD monitor is difficult to see, adjust the LCD monitor brightness (→P.58).

◆ Images That Can Be Viewed on the FinePix1300 ◆

You can use this camera to view still image data recorded on a FinePix1300 or still image data (excluding some uncompressed image data) recorded onto a 3.3V SmartMedia using a Fujifilm FinePix, MX or DX series digital camera.

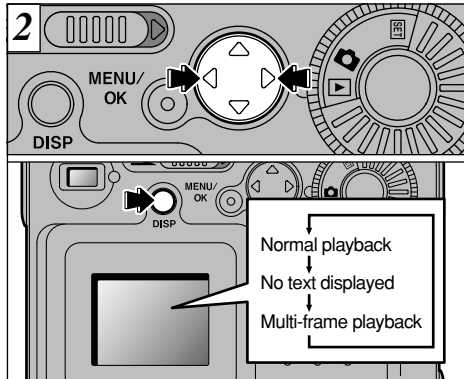

Use the “▶” button to view the next frame, and the “◀” button to view the previous frame. Each time you press the “DISP” button, the display on the LCD monitor switches to the next step in the cycle shown in the figure.

▶ PLAYBACK ZOOM

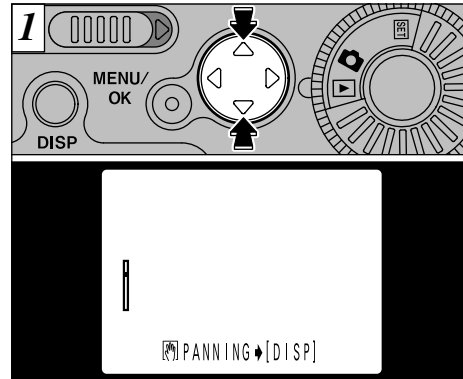

Pressing “▲” or “▼” during playback enlarges the image or reduces the image within the limits of the zoom bar.

- ! The maximum zoom scale is 4.0 ×.
- ! Pressing “◀” or “▶” during zooming cancels zooming and moves to the next image.

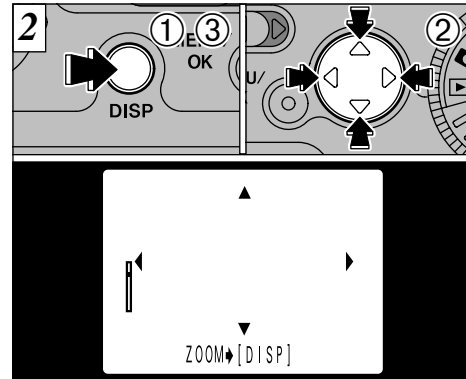

After you have zoomed in on your image,
① Press the “DISP” button.
② Use the “▲▼” and “◀▶” buttons to zoom in on different parts of the image.
③ Press the “DISP” button again to revert to zoomed display.

- ! Press the “MENU/OK” button to return to normal unscaled display.

▶ MULTI-FRAME PLAYBACK

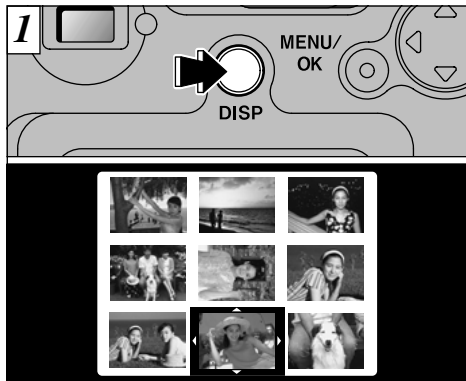

Pressing the "DISP" button twice switches to the multi-frame (9-frame) display.

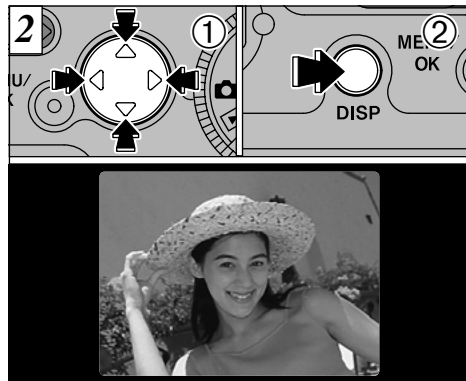

- ① Use the "◀▶", "▲▼" buttons to move the cursor (the orange outline) to the desired frame. Press "▲" or "▼" several times to move to the next screens.
- ② You can enlarge the selected image by pressing the "DISP" button again.

⚠ The "MENU/OK" button is disabled in multi-frame playback.

▶ → 🗑️ ERASING SINGLE FRAME

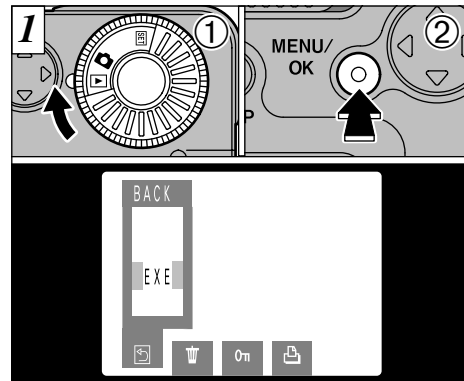

- ① Set the mode dial to "▶".
- ② Press the "MENU/OK" button to display the menu screen on the LCD monitor.

⚠ To exit the menu screen, select "🔙" (Back) and press the "MENU/OK" button.
⚠ See P.43-44 for more information on erasing all of the frames on a SmartMedia and formatting SmartMedia.

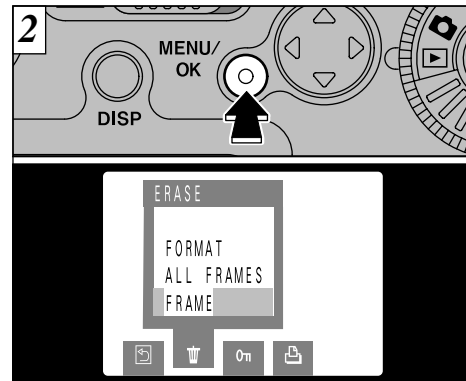

- ① Use "◀" or "▶" to select "FRAME" in the "🗑️ ERASE" menu.
- ② Press the "MENU/OK" button.

⚠ Multi-frame playback cannot be used in a menu screen.
⚠ The message shown on the LCD monitor multi-frame display disappears after about 3 seconds.

▶ → 🗑️ ERASING SINGLE FRAME

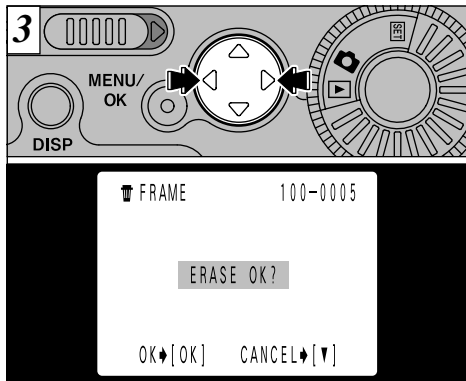

Use the “◀” and “▶” buttons to display the image to be erased.

⚠️ Press the “▼” button to cancel single-frame erase and return to the menu. To exit the menu, use the “◀” button to select “⏪” (Back) and then press the “MENU/OK” button.

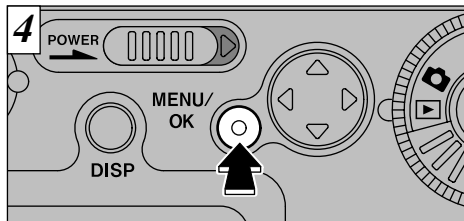

Press the “MENU/OK” button to erase the displayed image. When erasing is complete, the next image appears and the “ERASE OK?” message is displayed.

Press the “▼” button to cancel erasing and return to the menu.

- ⚠️ If “PROTECTED FRAME” is displayed, the protection settings must be reset (→P.45-48).
- ⚠️ If “DPOF” is displayed, the DPOF settings must be reset (→P.51-53).

To continue erasing images, repeat the procedure from step 3.

The Advanced Photography section introduces a range of camera functions that you can access by setting the Mode dial to “📷”.

■ Photography menu settings

Photography Mode	Settings	Factory default
📷 A Auto	⚡ Flash (→P.32) [AUTO/👁️/🔌/📷/🔌]	AUTO
	📷 Continuous Shooting (→P.35) [ON/OFF]	OFF
	⌚ Self-Timer (→P.36) [ON/OFF]	OFF
📷 M Manual	⚡ Flash (→P.32) [AUTO/👁️/🔌/📷/🔌]	AUTO
	☑️ Setting the Brightness (Exposure compensation) (→P.38) [-0.9 – +1.5]	0
	📷 Setting the White Balance (→P.39) [AUTO/🌞/🌙/🌧️/☀️/🌧️/🌞/🌙]	AUTO

* Flash photography and continuous shooting cannot be used together.

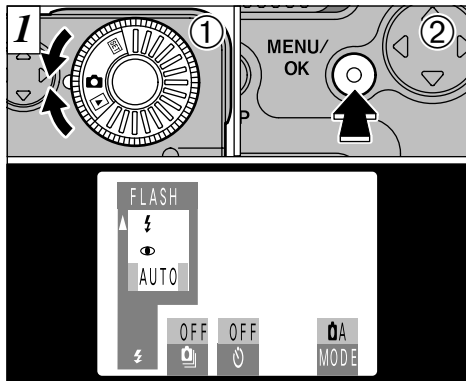

- ① Set the mode dial to “”.
- ② Press the “MENU/OK” button to display the menu on the LCD monitor.

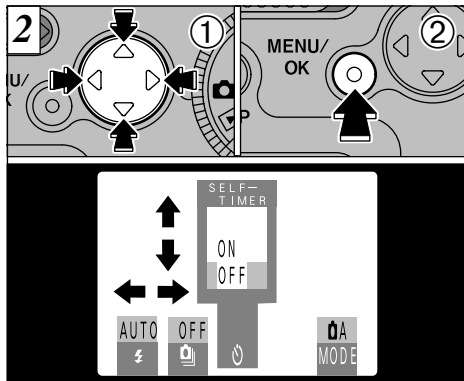

- ① Use the “” and “” buttons to select menu items and the “” and “” buttons to change the settings.
- ② Press the “MENU/OK” button to return to the Photography screen.

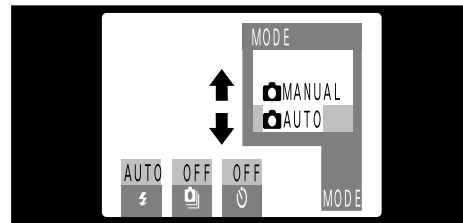

Select “ AUTO” or “ MANUAL” and press the “MENU/OK” button.

A Auto

This is the simplest mode to use and has a wide range of applications.

* You can specify the settings for “” (⇒P.32), “” (⇒P.35) and “” (⇒P.36).

M Manual

Manual mode allows you to take pictures using a particular set of desired menu settings.

* You can specify the settings for “” (⇒P.32), “” (⇒P.38) and “” (⇒P.39).

In the “ M” Photography mode, pressing the “DISP” button changes the display status one step in a 3-step cycle from “Show text and video” to “Show video only” to “Show text only” and so on.

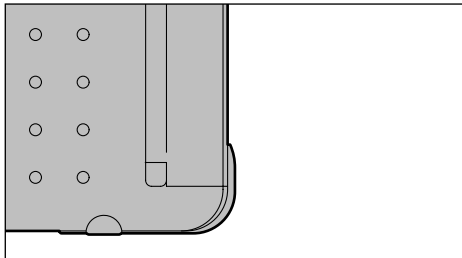

Auto Flash (no icon)

Use this mode for ordinary photography. The flash fires automatically as required by the conditions.

This option can be set in all photography modes. You can choose from 5 flash modes to suit your shot.

● Effective flash range

0.7 to 3.0m (2.3ft. to 9.8ft.).

- ⚠ You cannot perform flash photography and continuous shooting at the same time.
- ⚠ When the flash mode is set to Suppressed Flash, the camera becomes ready to shoot more quickly after you switch it on.
- ⚠ If you switch from Suppressed Flash mode to another flash mode, you may find that the displayed image disappears and the screen goes dark because the flash is charging. When this happens, the viewfinder lamp flashes orange.



👁 Red-Eye Reduction

Use this mode to ensure that the subject's eyes appear natural when photographing people in low-light conditions. The flash fires a pre-flash just before the picture is taken and then fires again to take the actual picture.

◆ Red-Eye Effect ◆

When you use the flash to photograph people in low-light conditions, their eyes sometimes appear red in the picture. This is caused by the light of the flash reflecting off the inside of the eye. Use Red-Eye Reduction flash mode to effectively minimize the likelihood of the red-eye effect.

Take the following measures also to make Red-Eye Reduction mode more effective:

- Get the subjects to look at the camera.
- Get as close as possible to the subjects.



⚡ Forced Flash

Use this flash mode to photograph backlit scenes, such as a subject against a window or in the shade of a tree, or to obtain the correct colors when you are shooting under lighting such as fluorescent tubes. In this mode, the flash fires in bright as well as dark conditions.



Suppressed Flash

In this mode, the flash never fires.

Use this mode when you are taking pictures in indoor lighting at distances too great for the flash to have any effect, such as theater performances or indoor sporting events. When you use Suppressed Flash, the Auto White Balance function (→P.64) operates so that natural colors are captured along with the ambience of the available light.

⚠ If you want to take a picture in low-light conditions with the flash mode set to Suppressed Flash, you should use a tripod to prevent camera shake.

⚠ See P.22 and P.71 for information on the camera shake warning.



Slow Synchro

This mode allows you to use the flash with a slow shutter speed.

This mode allows you to take beautiful pictures that show your subject and still capture the background.

⚠ Because slow shutter speeds are used, you should use a tripod to prevent camera shake.

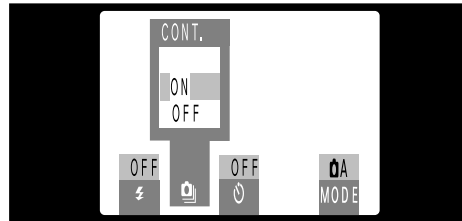

You can set the continuous shooting when the photography mode is set to "A".

When you select "ON", the following settings automatically change:

File size : Fixed at "640×480"

Flash : Fixed in Suppressed Flash mode

Continuous shooting continues for as long as you hold down the shutter button.

● **Continuous shooting specifications**

Number of shots per second: Approx. 2 shots

Number of consecutive shots: Up to 9 shots

Image size: Fixed at 640 × 480 pixels

⚠ The LCD monitor cannot be switched off during continuous shooting.

⚠ The exposure and white balance settings are fixed at the values current when the shutter button was pressed.

⚠ When the self-timer is used to take pictures, 9-frame photography is used.

⚠ You can also use digital zoom photography.

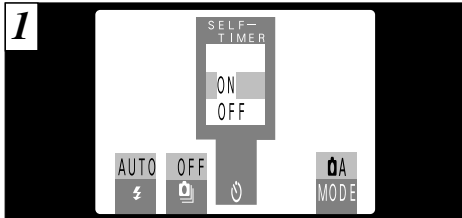

1 You can set the self-timer photography when the photography mode is set to "A". Select "ON" to switch to self-timer photography.

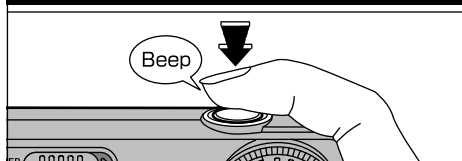

2 Compose the shot so that the subject is roughly in the center of the viewfinder or LCD monitor and then press the shutter button to set the correct exposure for the subject and start the timer running.

- ⚠ You can also use AE lock in this mode (→P.22).
- ⚠ Be careful not to stand in front of the camera when you press the shutter button since this can cause focusing or light metering errors.

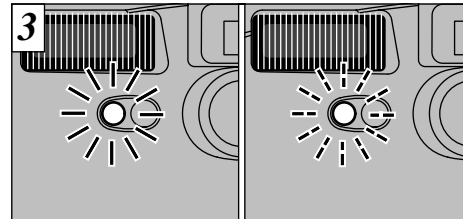

3 The self-timer lamp lights for 5 seconds, blinks for 5 seconds, then takes the picture.

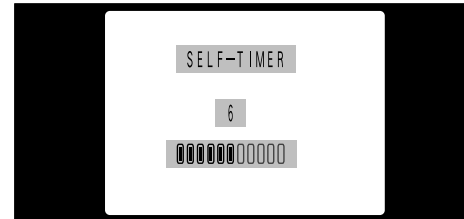

The time remaining until the picture is taken is counted down on the LCD monitor.

- ⚠ Self-timer mode is cancelled after you take the picture.
- ⚠ To stop the self-timer once it has started running, press the "▼" button.

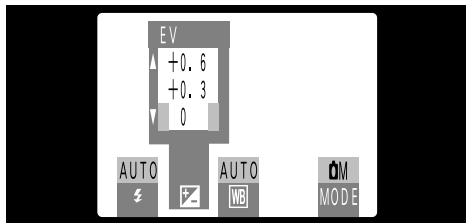

You can set the brightness when the photography mode is set to "M". Use the Brightness setting to obtain the optimum image brightness (exposure) when the subject is much brighter or darker than the background.

- There are 9 compensation levels (−0.9 to +1.5 EV in approx. 0.3 EV increments). See P.64 for a definition of EV.

The Brightness setting is disabled in the following situations:

- When the flash is used in Auto or Red-Eye Reduction mode
- When dark scenes are shot in Forced Flash mode

◆ Subjects for Which Exposure Adjustment is Particularly Effective ◆

Positive (+) Compensation

- Copying of printed text (black characters on white paper) (+1.5 EV)
- Backlit portraits (+0.6 to +1.5 EV)
- Very bright scenes (such as snowfields) and highly reflective subjects (+0.9 EV)
- Shots made up predominantly of the sky. (+0.9 EV)

Negative (−) Compensation

- Spotlit subjects, particularly against dark backgrounds (−0.6 EV)
- Copying of printed text (white characters on black paper) (−0.6 EV)
- Scenes with low reflectivity, such as shots of pine trees or dark foliage (−0.6 EV)

* Settings given in parentheses are a general guide.

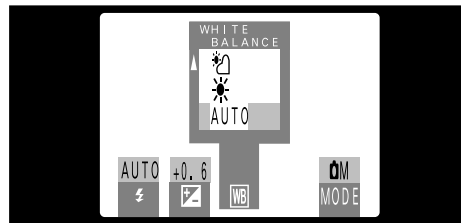

You can set the white balance when the photography mode is set to "M". When you want to fix the white balance for the surroundings and lighting of pictures to be taken, change the White Balance setting.

In Auto mode, the correct white balance may not be obtained for subjects such as close-ups of people's faces and shots taken under a special light source. In such situations, select the correct white balance for the light source. See P.64 for more information on the white balance.

- AUTO : Automatic adjustment (Shooting to show the ambience of the light source)
- : Shooting outdoors in fine weather
- : Shooting in shade
- : Shooting under "Daylight" fluorescent lamps
- : Shooting under "Warm White" fluorescent lamps
- : Shooting under "Cool White" fluorescent lamps
- : Shooting in incandescent light



* The White Balance setting is disabled when you use the flash. If you want to use the White Balance setting to achieve a particular effect, set the flash mode to Suppressed Flash.



MACRO (CLOSE-UP) PHOTOGRAPHY

Use the Macro function to take close-up shots.

● Effective photography range



Approx. 8-15 cm

If the flash is set to “AUTO” or “ Red-eye Reduction mode”, it is automatically set to “ Suppressed Flash mode”.

- ⚠ When shooting in dark conditions, use a tripod to prevent camera shake.
- ⚠ To use the flash, display the menu and select “ Forced flash” or “ Slow-synchro”. However, note that you may not get the correct exposure.

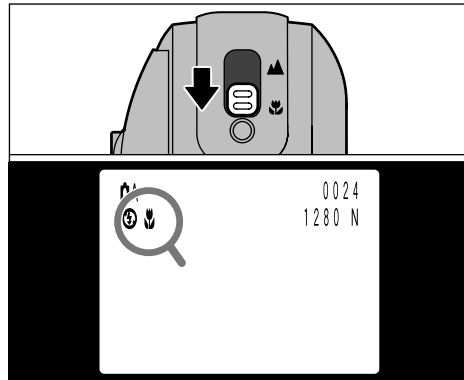
If you use the viewfinder to take a picture in Macro Photography, the field visible through the viewfinder does not match the field actually photographed because the viewfinder and lens are in different positions. For this reason, you should use the LCD monitor to take pictures in Macro Photography. The LCD monitor does not switch off in Macro Photography.



When you set the Normal/Macro selector button to the “” icon, “” appears on the LCD monitor and the camera switches to Macro photography.

Set the Normal/Macro selector button to the “” icon to return to Normal photography.

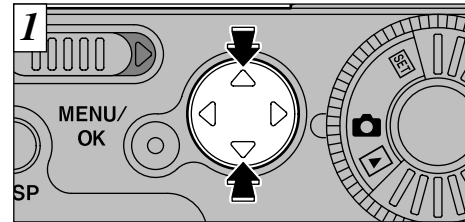

- ⚠ The LCD monitor is automatically switched on.
- ⚠ When you cancel Macro photography, the flash reverts to its previous mode. The LCD monitor will remain ON.

USING THE DIGITAL TELEPHOTO

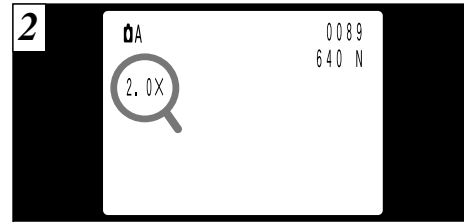

Digital telephoto photography allows you to enlarge the central portion of the image. Digital telephoto photography can only be used for images shot using the LCD monitor that have a file size setting of “640 × 480”.



If you press “” when you are taking pictures, the image enlarges and “2.0 ×” appears on the LCD monitor. Press “” to revert to the normal scale.

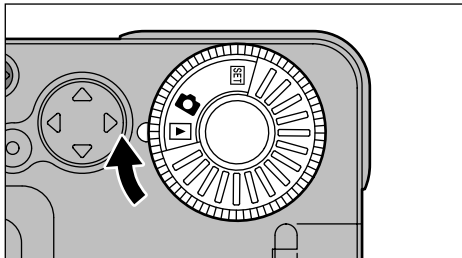

This section introduces a range of functions that you can access when the Mode dial is set to “▶”. The explanations below all presuppose that the Mode dial is set to “▶”.

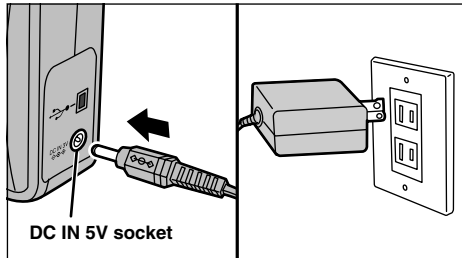

If there is a power socket handy, use the special AC Power Adapter AC-5V/AC-5VH (sold separately) so there is no need to worry about the batteries running out during playback (⇒P.13, 62).

FRAME(Erasing single frame)

Erases only the selected image.

- ⚠ You cannot use this function to erase protected images (⇒P.45, 47) or images with DPOF settings (⇒P.51, 53).

ALL FRAMES(Erasing all frames)

Erases all of the images.

- ⚠ You cannot use this function to erase protected images or images with DPOF settings.

FORMAT

Erases all of the data and reformats (initializes) the SmartMedia for use with this camera.

- ⚠ Formatting also erases protected images and images with DPOF settings.
- ⚠ If the “ CARD ERROR” message appears, wipe the contact surfaces on the SmartMedia (the gold-colored area) with a soft, dry cloth and then re-insert it into the camera.
If this does not resolve the problem, format the card.
- ⚠ If the “ CARD NOT INITIALIZED” message is displayed, format the card.

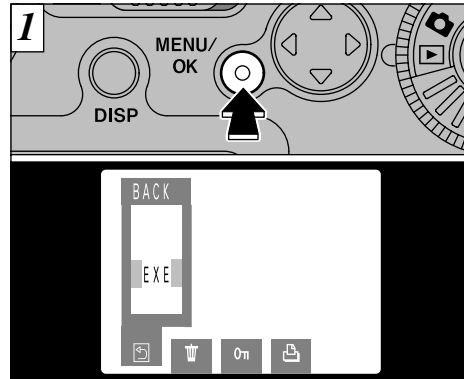

If you press the “MENU/OK” button, the menu screen will appear on the LCD monitor.

- ⚠ To exit the menu, use the “◀” or “▶” button to select “ BACK” and then press the “MENU/OK” button.

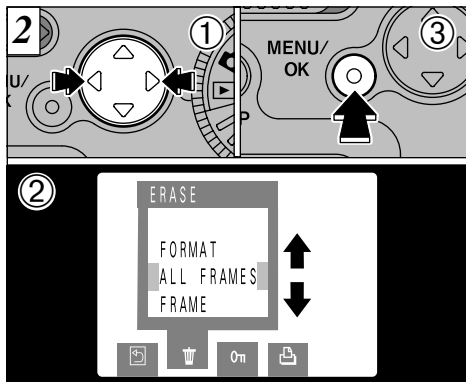

- ① Use the “◀” or “▶” button to select “ ERASE”.
- ② Use the “▲▼” button to select “FRAME”, “ALL” or “FORMAT”.
- ③ Press the “MENU/OK” button.

Formatting erases all of the data on the SmartMedia.

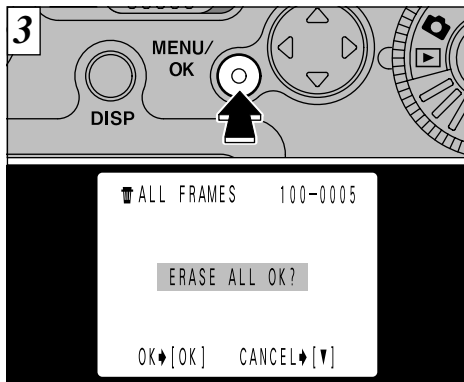

A confirmation screen appears. If you are erasing all the frames or formatting the card, press the “MENU/OK” button to proceed. If you are erasing one frame, use the “◀” and “▶” buttons to select the frame and then press the “MENU/OK” button.

- ⚠ To cancel single frame erase, all frame erase or media formatting, press the “▼” button.
- ⚠ If “ PROTECTED FRAME” or “ DPOF” is displayed, reset the respective settings.

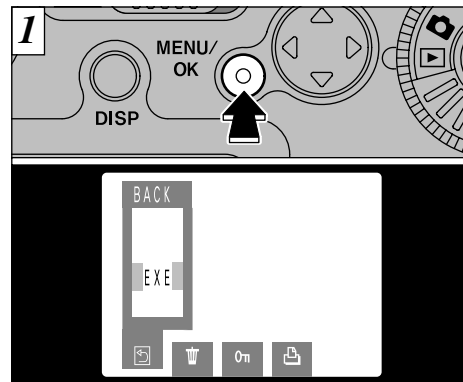

Press the “MENU/OK” button to display the menu on the LCD monitor.

- ⚠ To exit the menu, use the “◀” or “▶” button to select “ BACK” and then press the “MENU/OK” button.

“PROTECT” is a setting that prevents images from being accidentally erased. However, the FORMAT function erases all stored images, including protected images (→P.43).

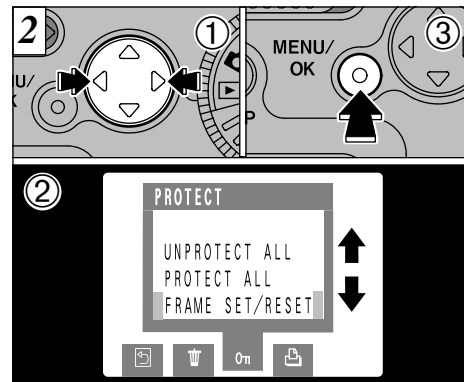

- ① Use the “◀” or “▶” button to select “ PROTECT”.
- ② Use the “▲▼” button to select “FRAME SET/RESET”.
- ③ Press the “MENU/OK” button.

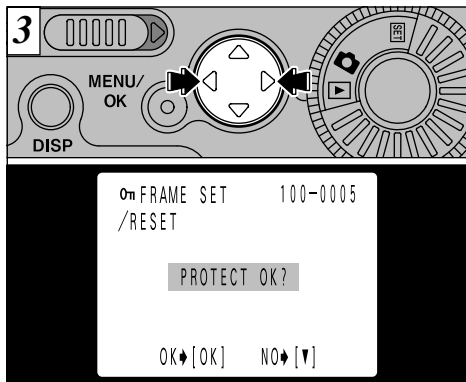

Use the “◀” or “▶” button to select the image to be protected.

! To cancel protection, press “▼” and return to the menu. To exit the menu, use the “◀” or “▶” button to select “BACK” and then press the “MENU/OK” button.

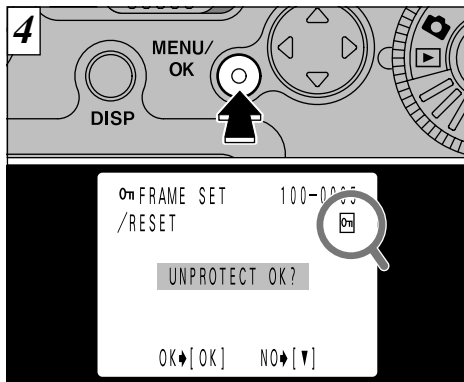

When the “MENU/OK” button is pressed, the image is protected and the “0m” icon appears on the right of the screen. To remove the protection, press the “MENU/OK” button again.

To protect another image, repeat the procedure from step 3.

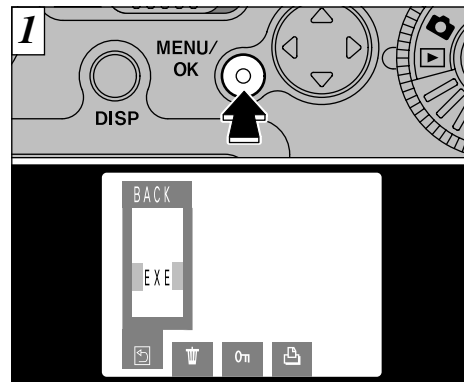

Press the “MENU/OK” button to display the menu on the LCD monitor.

! To exit the menu, use the “◀” or “▶” button to select “BACK” and then press the “MENU/OK” button.

Formatting erases all images, including protected images (→P.43).

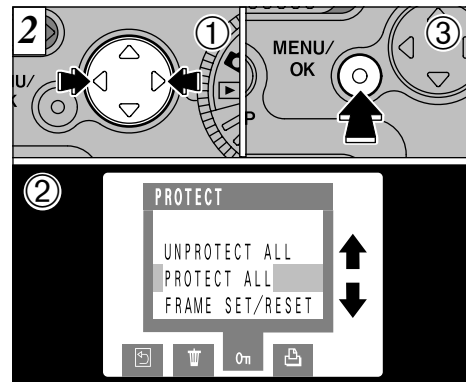

- ① Use the “◀” or “▶” button to select “0m PROTECT”.
- ② Use the “▲▼” button to select “PROTECT ALL” or “UNPROTECT ALL”.
- ③ Press “MENU/OK” button.

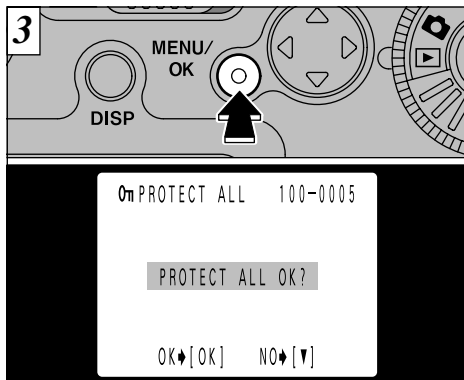

A confirmation screen will appear to protect all images. Press the “MENU/OK” button.

To cancel protection, press “▼” and return to the menu. To exit the menu, use the “◀” or “▶” button to select “BACK” and then press the “MENU/OK” button.



With the FinePix1300, you can order prints using the Digital Print Order Format (DPOF). You can use the DPOF to specify the following:

- The frames to be printed and the number of prints for each frame
- Imprinting of the date and time

This section gives a detailed description of how to order your prints with the FinePix1300.

* Note that some printers do not support date and time imprinting or specification of the number of prints.

* Note that the warnings shown below may be displayed while you are specifying the prints.

⚠ DPOF (⇒P.71)

You attempted to erase a frame with DPOF settings.

⚠ RESET UNMATCHED DPOF OK? (⇒P.71)

If you load a SmartMedia that contains frames specified for printing on another camera, those print specifications are all reset and replaced by the new print specifications.

⚠ CARD ERROR (⇒P.70)

No more than 1000 prints can be specified on the same SmartMedia.

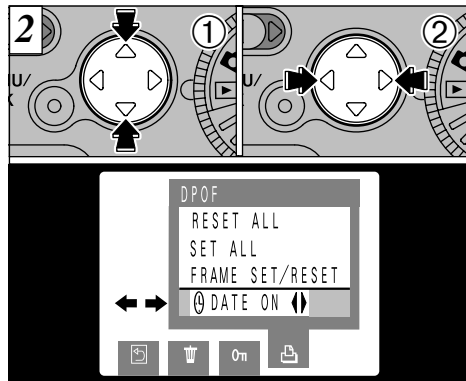
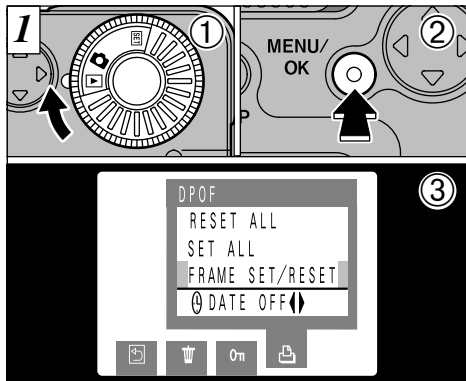

This function allows you to select whether or not the date of shooting is included on the print.

- ① Set the Mode dial to "DPOF".
- ② Press the "MENU/OK" button to display the menu on the LCD monitor.
- ③ Press "◀▶" button to select "DPOF".

50 To exit the menu, use the "◀" or "▶" button to select "BACK" and then press the "MENU/OK" button.

- ① Use the "▲▼" button to select "DATE".
- ② Press "◀" or "▶" button to specify "DATE ON" or "DATE OFF". This setting is then valid for all the prints until the setting is changed.

- ! Before specifying any other settings, first specify whether date is to be shown or not.
- ! If you switch the camera off after selecting "DATE ON", the setting reverts to "DATE OFF".

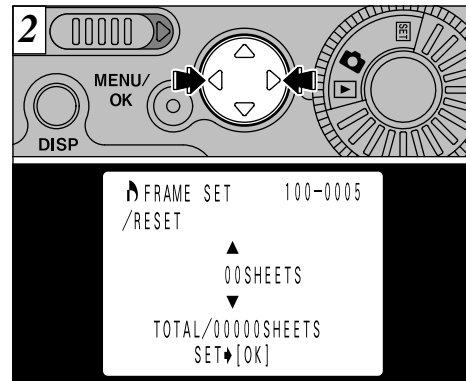
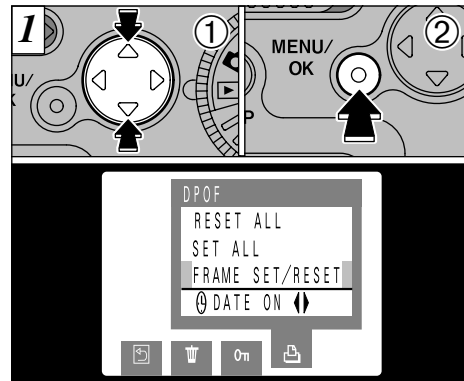

- ① Use the "▲▼" button to select "FRAME SET/RESET".
- ② Press the "MENU/OK" button.

To exit the menu, use the "◀" or "▶" button to select "BACK" and then press the "MENU/OK" button.

Use "◀" or "▶" to select the frame to be specified.

- ! Up to 99 prints can be specified for each frame, and the maximum number of frames for which prints can be specified on one SmartMedia is 999.
- ! "TOTAL" shows the total number of prints specified.

PLAYBACK MENU **DPOF FRAME SET/RESET**

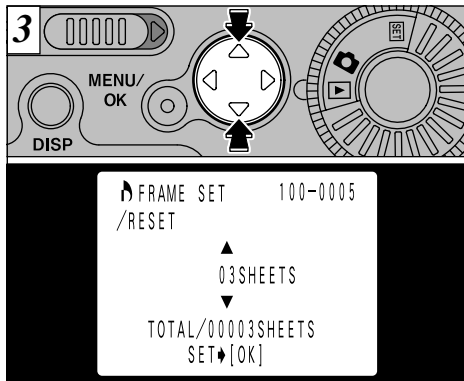

Use “▲” or “▼” to specify the number of prints.

- ⚠ The setting is not saved until you press the “◀” or “▶” button to move to another frame or press the “MENU/OK” button.
- ⚠ If you do not want a print of the frame, set (reset) the number of prints to “00 SHEETS”.

To specify DPOF settings for another frame, repeat the procedure from step 2.

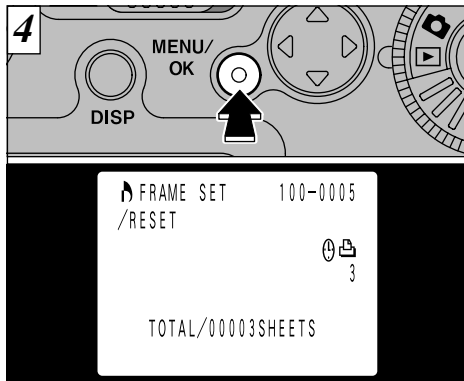

When you have completed the settings, always press the “MENU/OK” button to confirm the settings. The total number of prints is displayed on the LCD monitor and you are returned to the menu. The “ ” icon and the number of prints is displayed for confirmed frames and, if the date has been set, the “ ” icon is also displayed.

- ⚠ If you do not press the “MENU/OK” button, after 10 seconds the menu screen reappears. The settings for the last selected frame are discarded.

PLAYBACK MENU **DPOF SET ALL/RESET ALL**

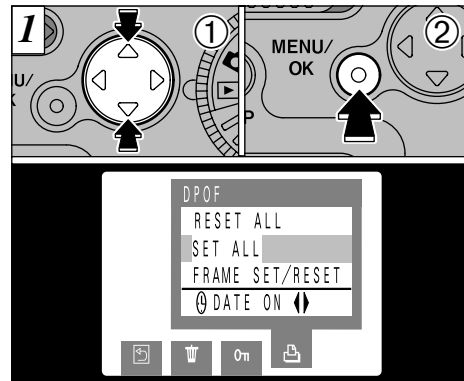

- ① Use “▲” or “▼” to select “SET ALL” or “RESET ALL”.
- ② Press the “MENU/OK” button.

- ⚠ “SET ALL” specifies 1 print for all the images.
- ⚠ The settings specified for individual frames are cancelled.
- ⚠ Prints can be specified for up to 999 frames on the same SmartMedia. If you specify more than 999 frames, the “ ” warning appears.

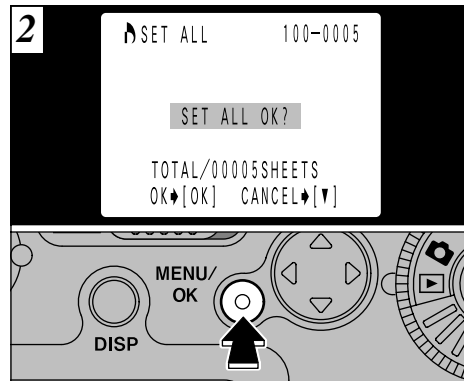

When you press the “MENU/OK” button, a confirmation screen appears. To proceed with the set or reset operation, press “MENU/OK”. The total number of prints is displayed on the LCD monitor and you are returned to the menu.

- ⚠ To exit the menu, use the “◀” or “▶” button to select “ BACK” and then press the “MENU/OK” button.
- ⚠ If you reset all the frames, the “TOTAL” display reverts to “00000”.

SET SET-UP MODE ▶ The table below explains the camera setting.

Settings	Display	Factory default	Explanation
FILE SIZE/ QUALITY SET	SET [OK]	1280×960 /NORMAL	Changing the combination of file size and compression ratio for image recording (⇒P.56).
BEEP	HIGH/LOW/OFF	HIGH	Selects the buzzer volume for camera operation. When this is set to OFF, the camera buzzer emits no sound.
DATE/TIME	SET [OK]	—	Sets the date and time (⇒P.17).
FRAME NO.	RENEW/CONT.	RENEW	Specifies whether the Frame NO. Memory function is used (⇒P.57).
LANGUAGE	ENGLISH/ FRANÇAIS	ENGLISH	Select English or French as the language used for screen display.

*See the following page for information on using the settings.

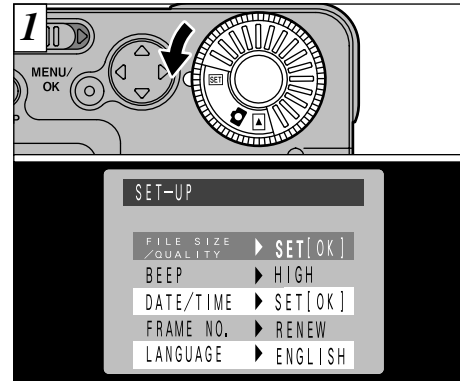

Set the mode dial to “SET”.

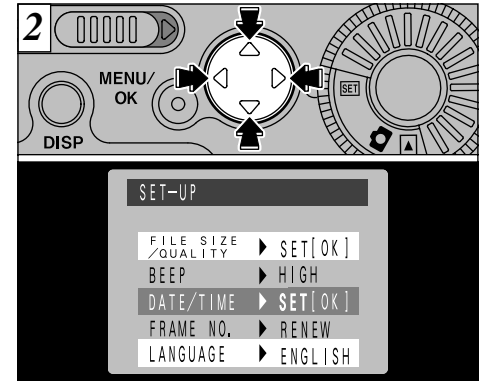

Use the “▲▼” buttons to select the desired item and then use the “◀▶” buttons to change and confirm the setting(not including the date /time setting and the file size/quality setting). To exit the SET-UP screen, set the Mode dial to “📷” or “📹”.

SETTING THE FILE SIZE AND QUALITY

You can select any combination of 2 file sizes (numbers of pixels) and 3 quality (compression ratio) settings. Select the combination that best suits your goals.

To get high-quality prints

Use a large image size (1280 × 960) with a low compression rate (FINE or NORMAL). However, because this increases the amount of data in each frame, the number of remaining shots decreases.

For images to be used on the Internet

These images are intended to be viewed on a personal computer screen, so you should use a small file size (640 × 480). This reduces the amount of data used for each shot and increases the number of remaining shots.

Quality (compression ratio)

Select "FINE" for better image quality, and "BASIC" to fit more shots on the SmartMedia.

In most cases, the "NORMAL" setting provides suitable image quality.

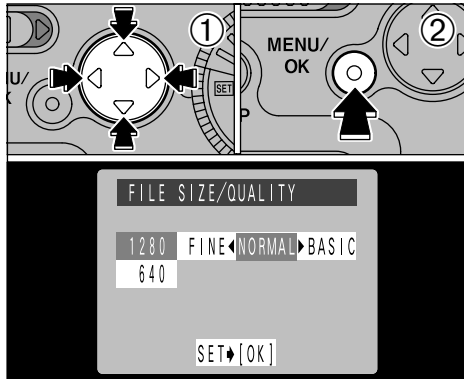

- ① Use "▲" or "▼" button to change the File Size setting and "◀" or "▶" button to change the Quality setting.
- ② Press "MENU/OK" to confirm the settings.

⚠ There are 4 combinations of file size and quality settings in total (→P.23).

FRAME NO. MEMORY

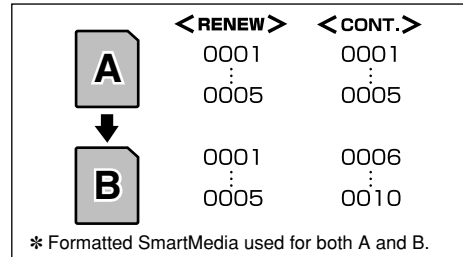

RENEW : Pictures are stored on each SmartMedia beginning with a file number "0001".

CONT. : Pictures are stored beginning from the highest file number stored on the last SmartMedia used.

Setting this function to "CONT." makes file management easier as it ensures that file names are not duplicated when images are downloaded to a PC.

⚠ If the SmartMedia already contains image files with file numbers higher than the highest file number on the last SmartMedia, images are stored beginning from the highest file number on the current SmartMedia.

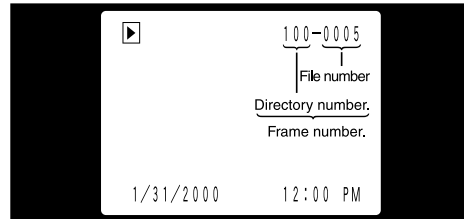

You can check the file number by viewing the image. The last 4 digits of the 7-digit number displayed in the top-right corner of the screen show the file number. The first 3 digits show the directory number.

⚠ When replacing the SmartMedia, always switch the camera off before you open the slot cover. If you open the slot cover while the camera is still switched on, the FRAME NO. (frame number memory) function will not operate.

⚠ File numbers run from 0001 to 9999. Once 9999 is exceeded, the directory number goes up by 1. The maximum number is 999-9999.

⚠ If you take a picture with FRAME NO. (frame number memory) set to RENEW, the stored "Last file No." setting is reset.

⚠ The frame number display for images shot on other cameras may differ.

ADJUSTING THE LCD MONITOR BRIGHTNESS

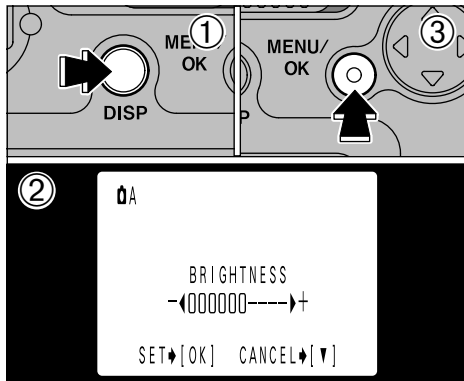

- ① If you hold down the "DISP" button for about 2 seconds, the brightness adjustment screen appears.
- ② Use the "◀" and "▶" buttons to adjust the brightness.
- ③ Press the "MENU/OK" button.

⚠ When the LCD monitor is switched off and no text is displayed in Photography mode (→P.19, 24, 31), the setting cannot be changed.

System Expansion Options

►By using the FinePix1300 together with other optional Fujifilm products, your system can be expanded to fill a wide range of uses.

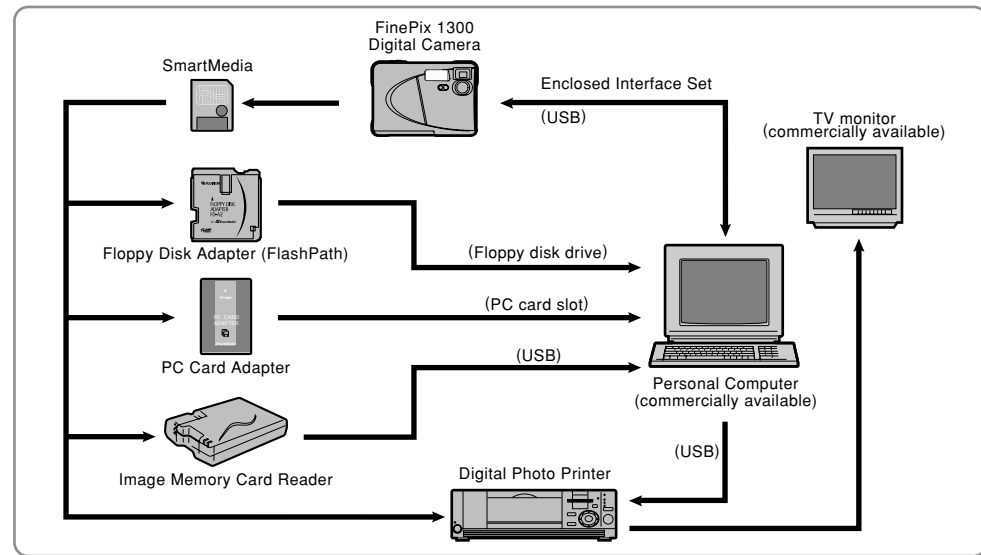

Downloading Images to a Personal Computer

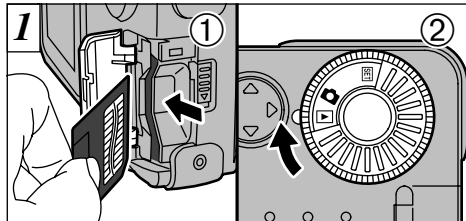

- ① Load the SmartMedia (→P.14).
- ② Switch the camera on (→P.16) and set the Mode dial to "▶".

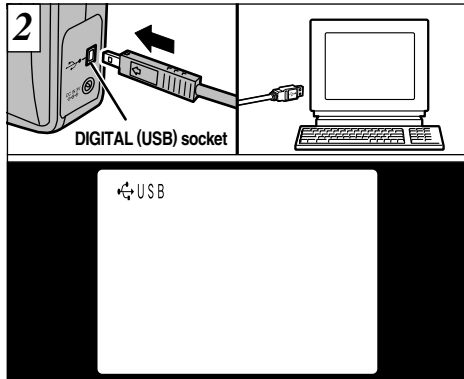

Fit the small plug on the special connection cable into the DIGITAL (USB) socket on the camera and then plug the other end of the cable into the USB socket on your personal computer. When you switch the PC on, "USB" appears in the upper left corner of the LCD monitor.

- ⚠ Use only the special USB cable provided.
- ⚠ Refer to the Quick Start Guide provided with the enclosed USB interface Set for information on installing and using the software.

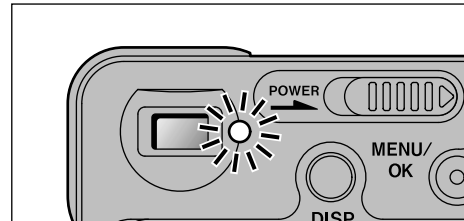

When the viewfinder lamp is lit orange or blinking green, data access (downloading) is in progress. Never open the slot cover or disconnect the cable during data access. This can prevent data downloading and cause camera malfunctions.

- ⚠ Opening the slot cover switches the camera off.

◆ Replacing the SmartMedia ◆

- ① Perform the following checks and operations:
 - **Windows 98**
Check that the viewfinder lamp is green.
 - **Windows 2000 Professional**
Check that the viewfinder lamp is green. Then click the "Eject" button in the taskbar.
 - **Macintosh**
Check that the viewfinder lamp is green. Then drag the "Removable drive" icon on the desktop to the Trash.
- ② Switch the camera off and replace the SmartMedia.

- ⚠ Always use the Interface Set provided with this product. Previous versions must not be used. If a previous version of the software is already installed on the computer, uninstall the previous version before you install the enclosed Interface Set software.

- ⚠ The optional AC Power Adapter AC-5V/AC-5VH should be connected to the camera for these operations. (→P.13) Any loss of power during data transmission will prevent successful data transfer.

- ⚠ Can be used with Windows 98 (including the second edition), Windows 2000 Professional and Mac OS 8.5.1 to Mac OS 9.0. However, your computer must have a USB port. (Self-made PC is not guaranteed.)

- ⚠ The Auto Power Off function does not operate when the camera is connected to a PC.

Accessories Guide

►The optional accessories (sold separately) can make taking pictures with the FinePix1300 even easier. For information on how to attach and use the accessories, refer to the instructions provided with the accessory used.

● SmartMedia™

These are separately available SmartMedia cards.

Use the following SmartMedia:

- MG-4S : 4MB, 3.3V
 - MG-8S : 8MB, 3.3V
 - MG-16S/SW : 16MB, 3.3V
 - MG-32S/SW : 32MB, 3.3V
 - MG-64S/SW : 64MB, 3.3V
- * Some 3.3V SmartMedia are labelled as “3V” or “ID” cards.

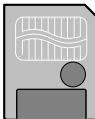

● AC Power Adapter AC-5V/AC-5VH

Use the AC-5V/AC-5VH when taking pictures for a long period of time or when the FinePix1300 is connected to a personal computer.

* The Shapes of the AC power adapter, the plug and socket outlet depend on the country.

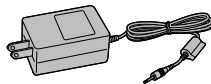

● Fujifilm Rechargeable Battery 2HR-3UF

The 2HR-3UF includes 2 pieces of high-capacity AA-size Nickel Metal Hydride batteries.

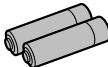

● Fujifilm Rechargeable Battery 4KR-3UF

The 4KR-3UF includes 4 pieces of high-capacity AA-size Ni-Cd batteries.

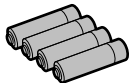

● Fujifilm Battery charger with Battery BK-NH (AC 220V only)

The BK-NH includes the quick battery charger BCH-NH and 2 Ni-MH batteries. The BCH-NH can charge 2 Ni-MH batteries in approximately 110 minutes. Up to 4 Ni-MH or Ni-Cd batteries can be charged simultaneously.

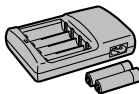

● Floppy Disk Adapter (FlashPath)

This adapter is the same size and shape as a 3.5-inch floppy disk. You can copy the images on a SmartMedia to your PC simply by loading the SmartMedia into the floppy disk adapter and then inserting the adapter into your floppy disk drive.

	Compatible OS	Compatible SmartMedia
FD-A1/A1S/A1N	Windows95/98, NT 4.0	5V/3.3V, 2MB to 32MB
FD-A2	Macintosh	5V/3.3V, 2MB to 64MB



● PC Card Adapter

The PC Card Adapter allows the SmartMedia to be used as a PC Card Standard ATA-compliant (PCMCIA 2.1) PC card (Type II).

- PC-AD2 : Compatible with SmartMedia of 5V/3.3V, 2MB to 8MB.
- PC-AD3 : Compatible with SmartMedia of 5V/3.3V, 2MB to 64MB.



● SM-R1/R2 Image Memory Card Reader

The SM-R1/R2 allows images to very easily be read and written from an image memory card (SmartMedia) to a personal computer. Its USB interface provides high-speed data transmission.

- Windows98, Windows 2000 Pro or Power Macintosh with USB interface.

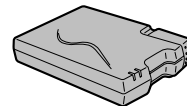

● SC-DX8 Soft Case

This case can be used when carrying the camera to protect it from dust, dirt and mild impacts.

Explanation of Terms

- AE Lock:** Press the shutter button down halfway to lock the exposure settings and enable AE Lock. Using AE Lock allows you to change the composition of your shot after you set the exposure, and still get excellent results.
- Auto Power Off Function:** If the camera is not used in any way for two minutes or more, the Auto Power Off function switches the camera off. This is to prevent battery depletion and to avoid wasting power when the camera is connected to the AC power adapter. Auto Power Off does not operate when the Auto Power Off function is disabled or a USB connection is used.
- DPOF:** Digital Print Order Format
DPOF is a format used for recording information on a storage media (image memory card, etc.) that allows you to specify which of the frames shot using a digital camera are printed and how many prints are made of each image.
- EV:** A number that denotes exposure. The EV is determined by the brightness of the subject and sensitivity (speed) of the film or CCD. The number is larger for bright subjects and smaller for dark subjects. As the brightness of the subject changes, a digital camera maintains the amount of light hitting the CCD at a constant level by adjusting the aperture and shutter speed. When the amount of light striking the CCD doubles, the EV increases by 1. Likewise, when the light is halved, the EV decreases by 1.
- JPEG:** Joint Photographics Experts Group
A file format used for compressing and saving color images. The compression ratio can be selected, but the higher the compression ratio, the poorer the quality of the expanded image.
- White Balance:** Regardless of the type of lighting, the human eye adapts so that a white object still looks white. On the other hand, devices such as digital still cameras register a white subject as white by first adjusting their internal color balance to match the color of the ambient light around the subject. This adjustment process is referred to as matching the white balance. A function that automatically matches the white balance is called **an auto white balance function**.

Notes on Using Your Camera Correctly

- Be sure to read this information in conjunction with “Safety Notes” (⇒P.76) prior to use, to ensure that you use your camera correctly.
- **Places to Avoid**
Do not store or use the camera in the following types of locations:
- Very humid, dirty or dusty places
 - In direct sunlight or in places subject to extreme temperature rises, such as in a closed car in summer.
 - Extremely cold places
 - Places subject to strong vibrations
 - Places affected by smoke or steam
 - Places subject to strong magnetic fields (such as places near motors, transformers or magnets)
 - For long periods in contact with chemicals such as pesticides or next to rubber or vinyl products
- **Do not expose the camera to sand.**
The FinePix1300 is particularly and adversely affected by sand. In sandy locations such as beaches or deserts, or in locations where there is wind borne sand, ensure that the camera is not exposed to sand. This can cause faults that may be irreparable.
- **Notes on Condensation**
If the camera is carried suddenly from a cold location into a warm place, water droplets (condensation) may form on the inside of the camera or on the lens. When the viewfinder lamp is lit orange or flashing orange, this indicates that data access is in progress. Condensation may also form on the SmartMedia card. In this event, remove the SmartMedia and wait a short time before using it again.
- **When the Camera is Unused for Long Periods**
If you do not intend to use the camera for a long period, of time remove the batteries and the SmartMedia card before storing the camera.
- **Cleaning Your Camera**
- Use a blower brush to remove dust from the lens and LCD surface and then wipe lightly with a soft, dry cloth. If any soiling remains, apply a small amount of lens cleaning liquid to a piece of Fujifilm lens cleaning paper and wipe gently.
 - Do not scratch hard objects against the lens, LCD monitor screen or viewfinder as these surfaces are easily damaged.
 - Clean the body of the camera with a soft dry cloth. Do not use volatile substances such as thinners, benzine or insecticide, as these may react with camera body and cause deformation or remove the coating.
- **When travelling overseas**
Do not place your camera in the check-in baggage. Baggage handling at airports may subject baggage to violent shocks, and the camera may be damaged internally even when no external damage is visible.

Notes on the Power Supply

Applicable Batteries

- AA-size alkaline, Ni-MH (nickel metal hydride), or Ni-Cd batteries can be used with this camera. Do not use AA-size manganese or lithium batteries in your FinePix1300 because the heat generated by the batteries could damage the camera or cause malfunctions.
- Because different brands of alkaline batteries have different capacities, the life of some batteries (the length of time for which they can be used) may be considerably shorter than that of the alkaline batteries supplied with this camera.

Notes on the Batteries

Incorrect use of the batteries could cause them to leak, become hot, ignite or burst. Always observe the precautions given below.

- Do not heat the batteries or throw them into a fire.
- Do not carry or store a battery with metal objects such as necklaces or hairpins that could come into contact with the metal positive ⊕ and negative ⊖ poles of the battery.
- Do not expose the batteries to fresh or sea water, and take particular care to keep the terminals dry.
- Do not attempt to deform, disassemble or modify the batteries.
- Do not attempt to peel off or cut the battery casing.
- Do not drop, strike or otherwise subject the batteries to strong impacts.

- Do not use batteries that are leaking, deformed, discolored or exhibit any other obvious abnormality.
- Do not store batteries in very warm or moist locations.
- Keep the batteries out of the reach of babies and small children.
- When loading the batteries in the camera, ensure that the battery polarity (⊕ and ⊖) is as indicated on the camera.
- Do not use new batteries together with used batteries. In the case of rechargeable batteries, do not use charged and discharged batteries together. Do not use batteries of different types or brands together.
- If you do not intend to use the camera for a long period of time, remove the batteries from the camera. (Note that if the camera is left with the batteries removed, the time and date settings are cleared.)
- The batteries may feel warm immediately after being used. Before removing the batteries, switch the camera off and wait until the batteries cool down.
- When replacing the batteries, always fit 4 new batteries. Here, 'new batteries' refers to either recently purchased unused alkaline batteries, or Ni-Cd or Ni-MH (nickel metal hydride) batteries that have recently been fully recharged together.
- Battery performance deteriorates at low temperatures (+10°C or below) and the time for which they can be used shortens. This is particularly true of alkaline batteries. In cold conditions, put the batteries in your pocket or a similar place to warm them before loading them into the camera. If you use a body warmer to warm the batteries, ensure that they are not in direct contact with the warmer.

- Soiling such as fingerprints on the battery terminals can markedly reduce the number of available shots. Carefully wipe the battery terminals clean with a soft dry cloth before loading the batteries.

⚠ If any liquid at all leaks from the batteries, wipe the battery compartment thoroughly and then load new batteries.
⚠ If any battery fluid comes into contact with your hands or clothing, flush the area thoroughly with water. Note that battery fluid can cause loss of eyesight if it gets in your eyes. If this occurs, do not rub your eyes. Flush the fluid out with clean water and contact your physician for treatment.

Disposing of Batteries

When disposing of batteries, do so in accordance with your local waste disposal regulations.

Notes on Small Rechargeable Batteries (Ni-MH or Ni-Cd batteries)

- Always use the special battery charger to charge AA-size Ni-MH or Ni-Cd batteries. Charge the batteries as described in the instructions provided with the battery charger.
- Do not use the battery charger to charge batteries other than those specified for use with the charger.
- Note that the batteries may feel warm immediately after being charged.
- Ni-MH and Ni-Cd batteries are not charged at shipment. Be sure to charge the batteries before using them.
- The camera mechanism is such that it draws a minute amount of current even when the camera is switched off.

Take particular care not to leave Ni-MH or Ni-Cd batteries in the camera for a long period of time as they can become excessively discharged and no longer be usable even when charged.

- Ni-MH and Ni-Cd batteries self-discharge even when not used. Always charge Ni-MH and Ni-Cd batteries before using them. If the time for which a battery provides power shortens markedly when it has been correctly charged, this indicates that the battery has reached the end of its effective life and should be replaced.

Notes on Using the AC Power Adapter

Always use the AC-5V AC Power Adapter AC-5V/AC-5VH (sold separately) with the FinePix1300 Digital Camera. The use of an AC power adapter other than the AC-5V/AC-5VH could result in damage to your camera.

- Ensure that you do not touch the contact areas on the AC power adapter against any other metal object as this could cause a short circuit.
- Do not plug the AC power adapter into the DIGITAL socket as this could damage your camera.
- Do not plug in the AC power adapter while you are operating the camera using batteries. Switch the camera off first.
- Do not load the batteries while you are operating the camera using the AC power adapter. Switch the camera off first.
- If you disconnect the AC power adapter when there are no batteries in the camera, the date may be cleared. If this occurs, reset the date.

Notes on the SmartMedia™

■ SmartMedia

The SmartMedia card supplied with your FinePix1300 camera is a new image recording medium developed especially for use in digital cameras. Each SmartMedia card contains a built-in semiconductor memory chip (NAND flash memory) which is used for storing digital image data. Because the data is stored electronically, the stored image data can be erased from the card and new data recorded.

■ SmartMedia with IDs

The SmartMedia ID is a SmartMedia that has an individually assigned identification number. SmartMedia ID cards can be used with devices that use ID numbers for copyright protection or other purposes. This camera accepts SmartMedia ID cards in the same way as conventional SmartMedia cards.

■ Storing Data

In the situations listed below, recorded data may be erased (destroyed). Please note that Fuji Photo Film Co., Ltd. accepts no responsibility whatsoever for the loss (destruction) of recorded data.

- *When the SmartMedia is used incorrectly by the owner or a third party
- *When the SmartMedia is exposed to static electricity or electrical noise
- *When the SmartMedia cover is opened or the

SmartMedia removed and the camera is then switched off during data recording, during data erasing (SmartMedia formatting) or during frame advance when images are being played back.

Back up important data onto another medium (MO disk, floppy disk, hard disk, etc.).

■ Notes on Handling SmartMedia

- When inserting the card into the camera, hold the SmartMedia straight as you push it in.
- Never remove the SmartMedia or switch the camera off during data recording, during data erasing (SmartMedia formatting) or during frame advance when images are being played back. These actions could result in damage to the SmartMedia.
- Use only the SmartMedia specified for use with the FinePix1300. The use of other SmartMedia could damage the camera.
- SmartMedia are precision electronic devices. Do not bend, drop, or subject SmartMedia to excessive shocks.
- Do not use or store SmartMedia in environments likely to be affected by strong static electricity or electrical noise.
- Do not use or store SmartMedia in very hot, humid or corrosive environments.
- Be careful not to touch the SmartMedia's contact area or allow the area to become soiled. Use a dry lint-free cloth to wipe away any soiling that does occur.

- To avoid damage caused by static electricity, always use the special static-free case provided during transportation or storage, or keep the SmartMedia in a storage case if available.
- Do not carry SmartMedia in locations such as a trouser pocket. This could subject the SmartMedia to excessive force when you sit down, therefore damaging the SmartMedia.
- The SmartMedia may feel warm when it is removed from the camera after extended periods of picture taking or image viewing. This is normal and does not indicate a fault.
- Inserting a SmartMedia that is charged with static electricity into your camera may result in a camera malfunction. If this occurs, switch the camera off and then on again.
- Affix the label onto the designated area of the card. Do not use third-party labels as this can lead to problems when the card is inserted or removed.
- When you attach the label, take care that it does not cover any of the write-protect area.

■ Notes on Using SmartMedia with a PC

- If you intend to take photos using a SmartMedia that has been used on a PC, format the SmartMedia on your camera.
- When you format a SmartMedia in the camera and then

shoot and record images, a directory (folder) is automatically created. Image data is then recorded in this directory.







- Do not change or delete the directory (folder) names or file names on the SmartMedia from your PC as this will make it impossible to use the SmartMedia in your camera.
- Always use the camera to erase image data on a SmartMedia.
- To edit image data, copy the image data to the computer's hard disk and then edit the copied data.





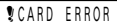
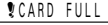

■ Specifications

Type	Image memory card for digital cameras (SmartMedia)
Operating voltage	3.3V
Operating conditions	Temperature: 0°C to +40°C (+32°F to +104°F) Humidity: 80% or less (condensation free)
Dimensions	37 × 45 × 0.76mm (1.45 × 1.77 × 0.03in.) (W × H × D)

Warning Displays

► The table below lists the warnings that are displayed on the LCD monitor.

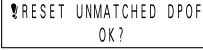
Warning Displayed	Explanation	Remedy
	The camera battery is low on charge.	Replace or recharge the battery.
	No SmartMedia is loaded, or it is loaded incorrectly.	Load a SmartMedia or reload the SmartMedia the correct way round.
	The SmartMedia is not formatted.	Format the SmartMedia.
	<ul style="list-style-type: none"> The SmartMedia contact area are soiled. The SmartMedia is damaged. The SmartMedia format is incorrect. 	Wipe the contact area on the SmartMedia with a soft dry cloth. It may be necessary to format the SmartMedia. If the error message is still displayed, replace the SmartMedia.
	The SmartMedia is fully recorded.	Erase some images or use a SmartMedia that has ample free space.
	The SmartMedia is write-protected.	Use a SmartMedia that is not write-protected.
	<ul style="list-style-type: none"> An attempt was made to playback incorrectly recorded data. An attempt was made to playback a frame not recorded on camera. 	Images cannot be played back.
	The frame number has reached 999-9999.	Switch the Frame NO. Memory function off and use a formatted SmartMedia to take the picture.

Warning Displayed	Explanation	Remedy
	There is a strong likelihood of camera shake because the shutter speed is slow.	Set the flash to Forced Flash mode or use a tripod.
	A protected frame was erased.	Remove the protection.
	You attempted to erase a frame with DPOF settings.	Reset the DPOF settings.
	Outside the AE continuous range.	The shot can be taken, but the exposure will not be correct.
	The DPOF file contains an error. Alternatively, the DPOF file was set up on a different device.	Press the MENU/EXE button to create a new DPOF file and specify all the DPOF settings again.
	Prints were specified for more than 1000 frames in the DPOF frame settings.	The maximum number of frames for which prints can be specified on the same SmartMedia is 999.

Troubleshooting

► Before you decide the camera is faulty, check the following once more.

Problem	Cause	Remedy
No power	<ul style="list-style-type: none"> The battery is exhausted. The AC power adapter plug has come out of the power outlet. 	<ul style="list-style-type: none"> Load a new battery. Plug the adapter back in.
Power cuts out during operation.	<ul style="list-style-type: none"> The battery is exhausted. 	<ul style="list-style-type: none"> Load new batteries.
Battery runs out quickly.	<ul style="list-style-type: none"> You are using the camera in extremely cold conditions. The terminals are soiled. The batteries are flat. 	<ul style="list-style-type: none"> Put the battery in your pocket or another warm place to heat it and then load it into the camera just before you take a picture. Wipe the battery terminals with a clean, dry cloth. Load a new battery.
No photograph is taken when the shutter button is pressed.	<ul style="list-style-type: none"> No SmartMedia is loaded. The SmartMedia is fully recorded. The SmartMedia is write-protected. The SmartMedia is not formatted. The SmartMedia contact area is soiled. The SmartMedia is damaged. The Auto Power Off function has switched the camera off. The battery is exhausted. 	<ul style="list-style-type: none"> Load a SmartMedia. Erase some images or use a SmartMedia that has ample free space. Remove the write-protection. Format the SmartMedia. Wipe the SmartMedia contact area with a clean dry cloth. Load a new SmartMedia. Switch the camera on. Load new batteries.
I can't use the flash to take pictures.	<ul style="list-style-type: none"> The flash is set to Suppressed Flash mode. The camera is in continuous shooting mode. 	<ul style="list-style-type: none"> Set the flash mode to Auto, Red-eye Reduction, Forced Flash or Night Scene. Set continuous shooting to "OFF".

Problem	Cause	Remedy
I can't use the flash to take pictures.	<ul style="list-style-type: none"> The camera switches to Macro mode. The shutter button was pressed when the viewfinder indicator was blinking orange. 	<ul style="list-style-type: none"> Cancel Macro mode (allows forced flash and slow-synchro photography). Wait until the flash has finished charging before pressing the shutter button.
The flash will not charge.	<ul style="list-style-type: none"> No compatible SmartMedia is loaded. The camera is set to Suppressed Flash mode. The battery is exhausted. 	<ul style="list-style-type: none"> Load a new SmartMedia, erase a frame, or remove the write-protection. Set the flash mode to Auto, Red-eye Reduction, Forced Flash or Night Scene. Load new batteries.
The playback image is too dark even though I used the flash.	<ul style="list-style-type: none"> The subject is too far away. Your finger is covering the flash. 	<ul style="list-style-type: none"> Move closer to the subject. Hold the camera correctly.
The image is blurred.	<ul style="list-style-type: none"> The lens is soiled. Macro photography was used to photograph scenery. 	<ul style="list-style-type: none"> Clean the lens. Cancel Macro photography.
I cannot format the SmartMedia.	<ul style="list-style-type: none"> The SmartMedia is write-protected. 	<ul style="list-style-type: none"> Remove the write-protection. (Peel off the write-protect sticker.)
I cannot erase all the frames.	<ul style="list-style-type: none"> The frame is protected. DPOF settings are specified for one or more of the frames. 	<ul style="list-style-type: none"> Remove the frame protection. Reset the DPOF settings.
Nothing happens when I use the camera buttons and switches.	<ul style="list-style-type: none"> Camera malfunction. The Mode dial has been moved to another setting. The battery is exhausted. 	<ul style="list-style-type: none"> Remove the battery, re-insert them and try again. Move the Mode dial to the correct setting. Load new batteries.
No image appears when I press the, "DISP" button.	<ul style="list-style-type: none"> The Mode dial is set incorrectly. 	<ul style="list-style-type: none"> Move the Mode dial to the correct setting.

Specifications

System

- Model
Digital Camera
- Pickup Elements
1/2.7-inch square pixel CCD (1.31 million pixels)
- Resolution
1280×960 pixels/640×480 pixels
- File format
JPEG (Exif Ver.2.1),
*Design for Camera File system compliant, DPOF-compatible
- Viewfinder
Real Galileo type ; Frame coverage : 80%
- Lens
Fujinon optical fixed-focus lens F4.5/F11
- Storage media
SmartMedia (3.3V)
- Number of frames recorded

- Focus distance
f = 5.8mm (equivalent to 36mm on a 35mm camera)
- Exposure control
64 zones TTL metering, Program AE
(exposure compensation available in Manual mode)
- Sensitivity
Equivalent to ISO 125
- White balance
Auto-selected (7 modes selectable in Manual mode)
- Focal range
Normal : Approx. 70cm/2.3ft. to infinity
Macro : Approx.8-15cm/3.1-5.9in
- Shutter speeds
Variable-speed, 1/2 to 1/1000 sec.(combined with mechanical shutter)
- Flash (Auto flash using flash control sensor)
Effective range : Approx. 0.7 - 3.0m (2.3ft -9.8ft)
Flash modes : Auto, Red-Eye Reduction, Forced Flash, Suppressed Flash, Slow Synchro

Pixel	1280 × 960			640 × 480
	FINE	NORMAL	BASIC	NORMAL
Quality Mode	Approx.1/4	Approx.1/8	Approx.1/16	Approx.1/8
Compression Ratio	Approx.610KB	Approx.310KB	Approx.160KB	Approx.90KB
Image Data Size	6	12	23	44
4MB (MG-4S)	12	24	47	89
8MB (MG-8S)	25	49	89	164
16MB (MG-16S/SW)	50	99	180	330
32MB (MG-32S/SW)	101	198	362	663
64MB (MG-64S/SW)				

- LCD monitor
1.6-inch, 55,000-pixel D-TFD
- Self-Timer
10 sec. timer clock

Input/Output Terminals

- Digital
USB (1) for image data output with a personal computer
- DC Input
Socket for specified AC power adapter

Power Supply and Others

- Power supply
Use one of the following:
 - 4AA-size alkaline batteries
 - 4AA-size Ni-MH (nickel metal hydride) batteries (sold separately)
 - 4AA-size (Minimum 1,000mAn) Ni-Cd (nickel-cadmium) batteries (sold separately)
 - AC Power Adapter AC-5V/AC-5VH (sold separately)
- No. of available shots using battery (battery life)

Battery type	With LCD monitor ON	With LCD monitor OFF
Alkaline batteries	Approx.260 frames	Approx.800 frames
Ni-MH battery HR-3UF	Approx.300 frames*	Approx.800 frames*
Ni-Cd battery KR-3UF	Approx.180 frames*	Approx.500 frames*

* With fully charged battery

This indicates the number of available frames shot consecutively at room temperature with a flash use rate of 50%. Note that these figures may vary depending on the ambient temperature and the amount of charge in the battery.

- Conditions for use
Temperature : 0°C to +40°C (+32°F to +104°F) ; 80% humidity or less (no condensation)
- Camera dimensions (W/H/D)
110×77×39mm/4.3×3.0×1.5in. (not including accessories and attachments)
- Camera mass (weight)
Approx. 200g/7.1oz (not including accessories, batteries or SmartMedia)
- Weight for photography
Approx. 300g/10.6oz (including batteries and SmartMedia)
- Accessories
See P.7
- Optional Accessories
See P.62, 63



* These specifications are subject to change without notice.
* The LCD monitor on your digital camera is manufactured using advanced high-precision technology. Even so, small bright points and anomalous colors (particularly around text) may appear on the monitor. These are normal display characteristics and do not indicate a fault with the monitor. This phenomenon will not appear on the recorded image.
* The electrostatic discharge can in some cases cause problems. This is not a malfunction of FUJIFILM Digital Cameras.

Safety Notes



- To ensure that you use your FinePix1300 camera correctly, read these Safety Notes and your Owner's Manual carefully beforehand.
- After reading these Safety Notes, store them in a safe place.





About the Icons





The icons shown below are used in this document to indicate the severity of the injury or damage that can result if the information indicated by the icon is ignored and the product is used incorrectly as a result.







	WARNING	This icon indicates that death or serious injury can result if the information is ignored.
	CAUTION	This icon indicates that personal injury or material damage can result if the information is ignored.

The icons shown below are used to indicate the nature of the information which is to be observed.







-  Triangular icons notify the user of information requiring attention ("Important").
-  Circular icons with a diagonal bar notify the user that the action indicated is prohibited ("Prohibited").
-  Filled circles with an exclamation mark notify the user of an action that must be performed ("Required").





 WARNING	
<p>When a fault arises, switch the camera off and then remove the batteries and disconnect the AC power adapter.</p> <p>Continued use of the camera when it is emitting smoke, is emitting any unusual odor, or is in any other abnormal state can cause a fire or electric shock.</p> <ul style="list-style-type: none"> ● Contact your Fujii dealer. 	 Unplug from power socket.
<p>Do not allow water or foreign objects to enter the camera.</p> <p>If water or a foreign object has entered the camera, switch the camera off and then remove the batteries and disconnect the AC power adapter.</p> <p>Continued use of the camera can cause a fire or electric shock.</p> <ul style="list-style-type: none"> ● Contact your Fujii dealer. 	
<p>Do not place the camera on an unstable surface.</p> <p>This can cause the camera to fall or tip over and cause injury.</p>	
<p>Do not use the camera in the bathroom or shower.</p> <p>This can cause a fire or electric shock.</p>	 Do not use in the bathroom or shower.

 WARNING	
<p>Never attempt to modify or disassemble the camera. (Never open the casing.)</p> <p>Do not use the camera when it has been dropped or the casing is damaged.</p> <p>This can cause a fire or electric shock.</p> <ul style="list-style-type: none"> ● Contact your Fujii dealer. 	 Do not disassemble.
<p>Never attempt to take pictures whilst in motion.</p> <p>Do not use the camera while you are walking or operating a moving car or other vehicle.</p> <p>This can result in you falling down or being involved in a traffic accident.</p>	
<p>Do not heat, modify or attempt to disassemble the batteries.</p> <p>Do not drop or subject the batteries to impacts.</p> <p>Do not attempt to recharge lithium or alkaline batteries.</p> <p>Do not store the batteries with metallic products.</p> <p>Any of these actions can cause the batteries to burst or leak and cause fire or injury as a result</p>	

 WARNING	
<p>Do not touch any metal parts of the camera during a thunderstorm.</p> <p>This can cause an electric shock due to induced current from the lightning discharge.</p>	
<p>Do not use the batteries except as specified.</p> <p>Load the batteries with the poles positioned as indicated by the ⊕ and ⊖ marks.</p>	
<p>Use only the batteries or AC power adapter specified for use with this camera.</p> <p>The use of other power sources can cause a fire.</p>	
<p>If the battery leaks and fluid gets into your eyes or comes into contact with your skin or clothing, this can cause injury or loss of eyesight. Immediately flush the affected area thoroughly with clean water and seek medical treatment.</p>	
<p>When discarding or storing batteries, cover the battery terminals with insulation tape.</p> <ul style="list-style-type: none"> ● Contact with other metallic objects or batteries could cause the batteries to ignite or burst. 	

Safety Notes

 CAUTION	
<p>Do not use this camera in locations severely affected by oil fumes, steam, humidity or dust.</p> <p>This can cause a fire or electric shock.</p>	
<p>Do not leave this camera in places subject to extremely high temperatures.</p> <p>Do not leave the camera in locations such as a sealed vehicle or in direct sunlight.</p> <p>This can cause a fire.</p>	
<p>Do not place heavy objects on the camera.</p> <p>This can cause the heavy object to tip over or fall and cause injury.</p>	
<p>Do not move the camera while the AC power adapter is still connected.</p> <p>This can damage the power cord or cables and cause a fire or electric shock.</p>	
<p>Do not cover or wrap the camera or the AC power adapter in a cloth or quilt.</p> <p>This can cause heat to build up and distort the casing or cause a fire.</p>	

 CAUTION	
<p>Remove the batteries and disconnect the AC power adapter when you are cleaning the camera or if you intend to leave the camera unused for a long period.</p> <p>Failure to do so can cause a fire or electric shock.</p>	
<p>Do not use the flash close to anyone's eyes.</p> <p>This can cause temporary damage to the person's eyesight.</p>	
<p>Request regular internal testing and cleaning for your camera.</p> <p>Build-ups of dust in your camera can cause a fire or electric shock.</p> <ul style="list-style-type: none">● Contact your Fuji dealer to request internal cleaning every 2 years.	



FUJI PHOTO FILM CO., LTD.

26-30, Nishiazabu 2-chome, Minato-ku, Tokyo 106-8620, Japan

Printed in Japan

Printed on recycled paper.

FGS-002108-FG